

ORAMA MINI LOK FRAMES

Orama Architectural Catalogue

Edition 2.0 / 9 · 2015

First Edition 10 · 2014

Technical drawings: **Orama R & D**

Catalogue design: **Role Play** / roleplay.gr

2	Introduction
3	Technical sheet
4	OMICRON
4.1	Typical Sections
4.2	Multitrack Frames
4.3	Labyrinth Profiles
4.4	Glass Combinations
4.5	Invisible base
5	ΩMEGA
5.1	Typical Sections
5.2	Multitrack Frames
5.3	Labyrinth Profiles
5.3	Glass Combinations
6	Handle
7	Installation Mode
8	Main frame solutions
8.1	F Fix
8.2	FF Double Fix
8.3	SS Double Sliding
8.4	SF Sliding Fix
8.5	Pocket single track
8.6	Pocket double track
8.7	FSSF Sliding on different track
8.8	FSSF Sliding on same track
8.9	FSF Fix · Sliding · Fix
8.10	SSF Double Sliding · Fix
8.11	SSS Triple Sliding
8.12	FSFSF Fix · Sliding · Fix · Sliding · Fix
8.13	F+F Fixed corner
8.14	FF+FF Double fixed corner
8.15	FS+SF Open corner sliding inside
8.16	FS+SF Open corner sliding outside
9	Wind load diagrams
10	Thermal performance

INTRODUCTION

2

A completely new system has been elaborated, based on a 20 year experience in aluminum profiles, aiming to meet the highest standards in elegance, comfort, performance and reasonable prices.

The system offers the excellent **Uw values** with double and triple glazing which meet the demands of the most critical environments.

All sliding typologies are available including **single, double, and triple track systems** as well as **corner-free** solutions that open your vision to 360 degrees.

The **high capacity stainless steel rollers and tracks** allow smooth and silent sliding action and extreme ease of movement with large glass areas.

Concealed **locks** can be used to increase operating comfort and to increase the security level of the opening.

The aluminium windows can be **fully integrated into the wall, ceiling and floor**, which results in a completely invisible frame and increased vision to the outside environment.

The high-quality multi-locking point system developed by ORAMA offers the best possible **burglar resistance** in accordance with European standards.

A new evolution has been created in the concept of drainage, increasing the speed of draining away water.











OMICRON is our standard minimal frames system incorporating all the significant features of the Orama system in a double-glazed setup.









ΩMEGA is an advanced minimal frames system able to deliver higher insulation performance and bigger sizes through thicker triple glazing.



	OMICRON	ΩMEGA	
Facing width	24 - 30mm	24 - 30mm	
Installation flush to the floor	yes	yes	
Installation flush to the ceiling	yes	yes	
Max. leaf height	4.5m	6.5m	
Max. leaf width	3m	3m	
Max. leaf weight	500kg	1000kg	
Max. sliding leaf area	12m ²	16m ²	
Max. fix leaf dimension	18m ²	21m ²	
Glass thickness	30 - 36 mm	46 - 54 mm	

· THE ORAMA CERTIFICATES ·

	OMICRON	ΩMEGA	
Uw values (depending on glass type & dimension)	From 0,7 to 1,7 W/m ² K		
Air permeability	EN 12207 : Class 4		
Resistance to rain penetration	EN 12208 : Class 7A	EN 12208 : Class 8A	
Resistance to wind loads	EN 12210 : Class C5		
Sound insulation	up to 42 dB DIN EN ISO 140-3:2005		
Resistance to burglary	ENV 1627 WK-2/RC-2 (under testing)		

OMICRON • TYPICAL SECTIONS

4.1

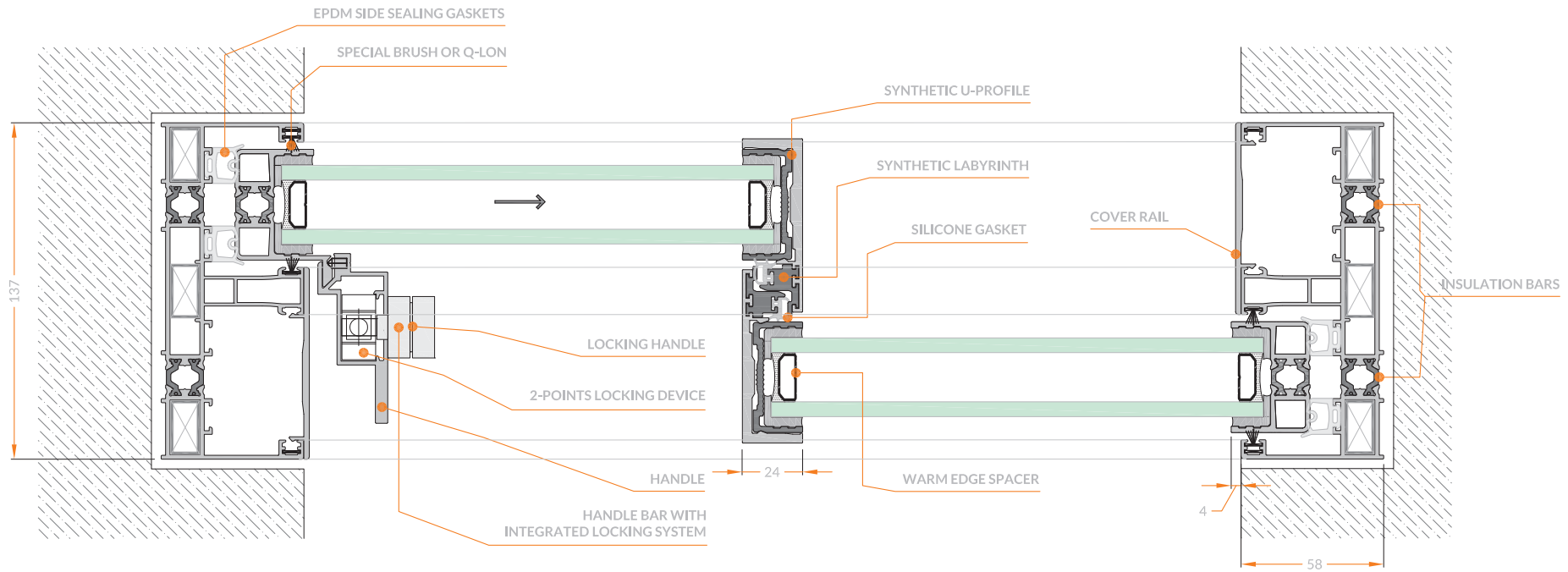

HORIZONTAL SECTION

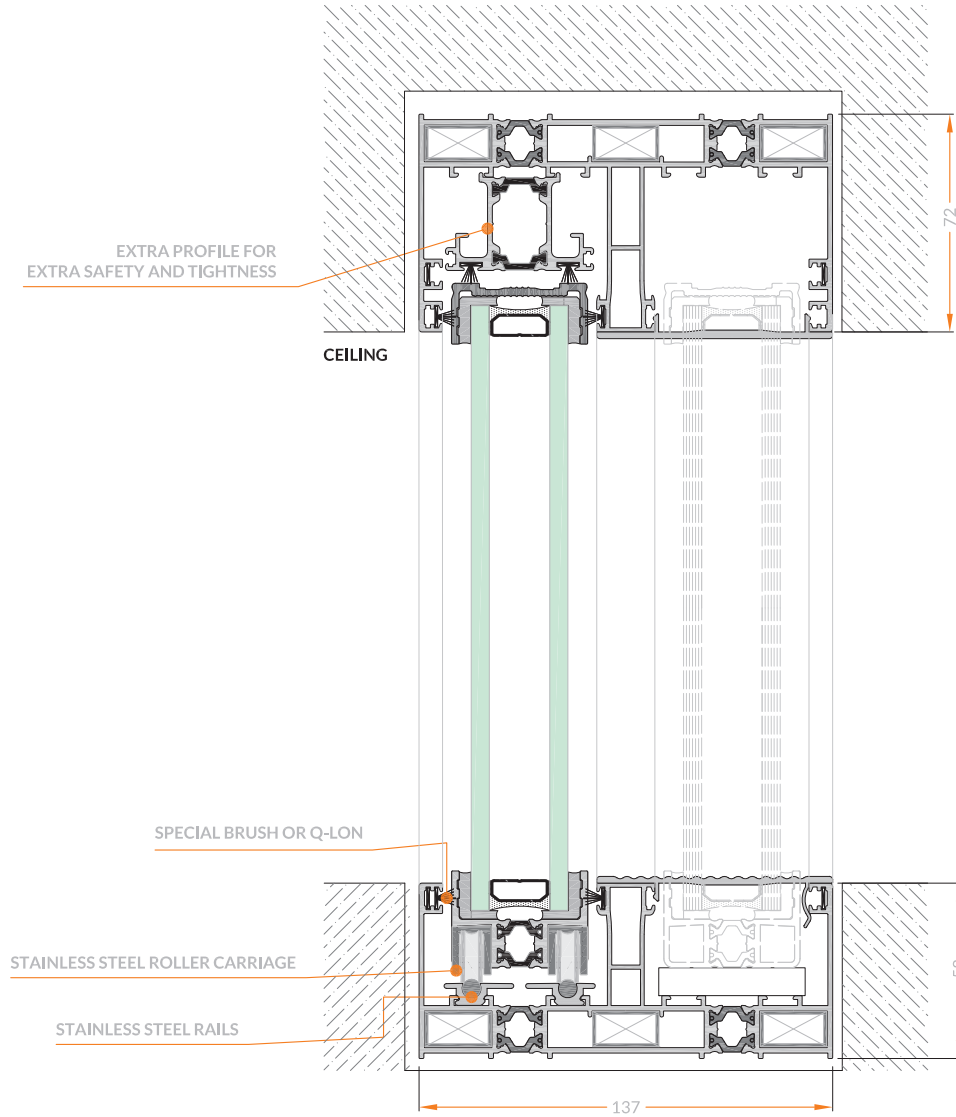

VERTICAL SECTION

OMICRON • MULTI-TRACK FRAMES

4.2

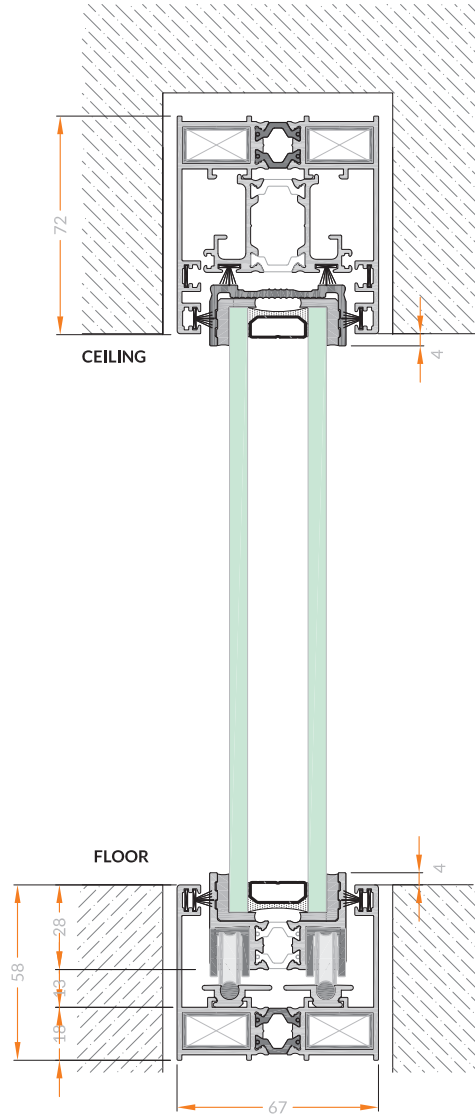

SINGLE TRACK FRAME • SLIDING • FIX

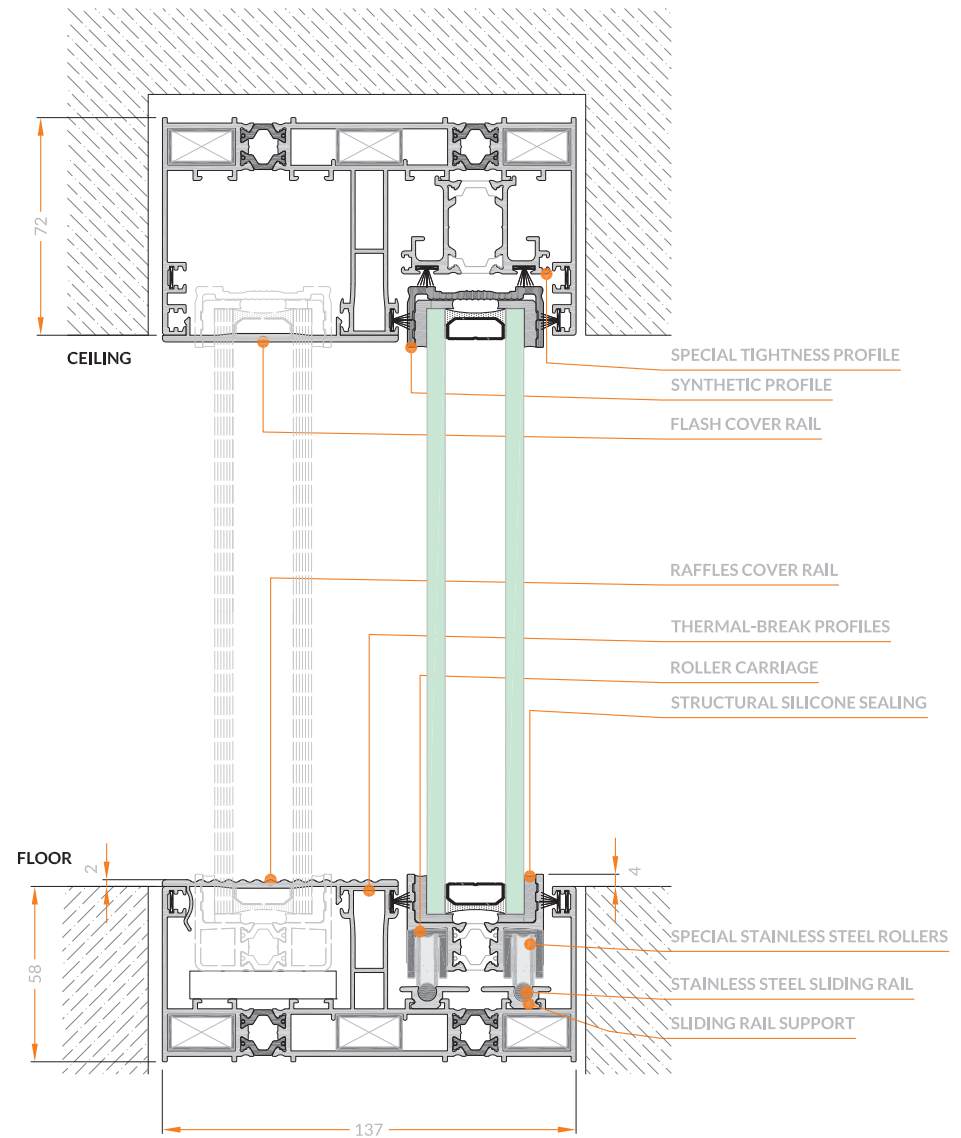

DOUBLE TRACK FRAME • SLIDING • FIX

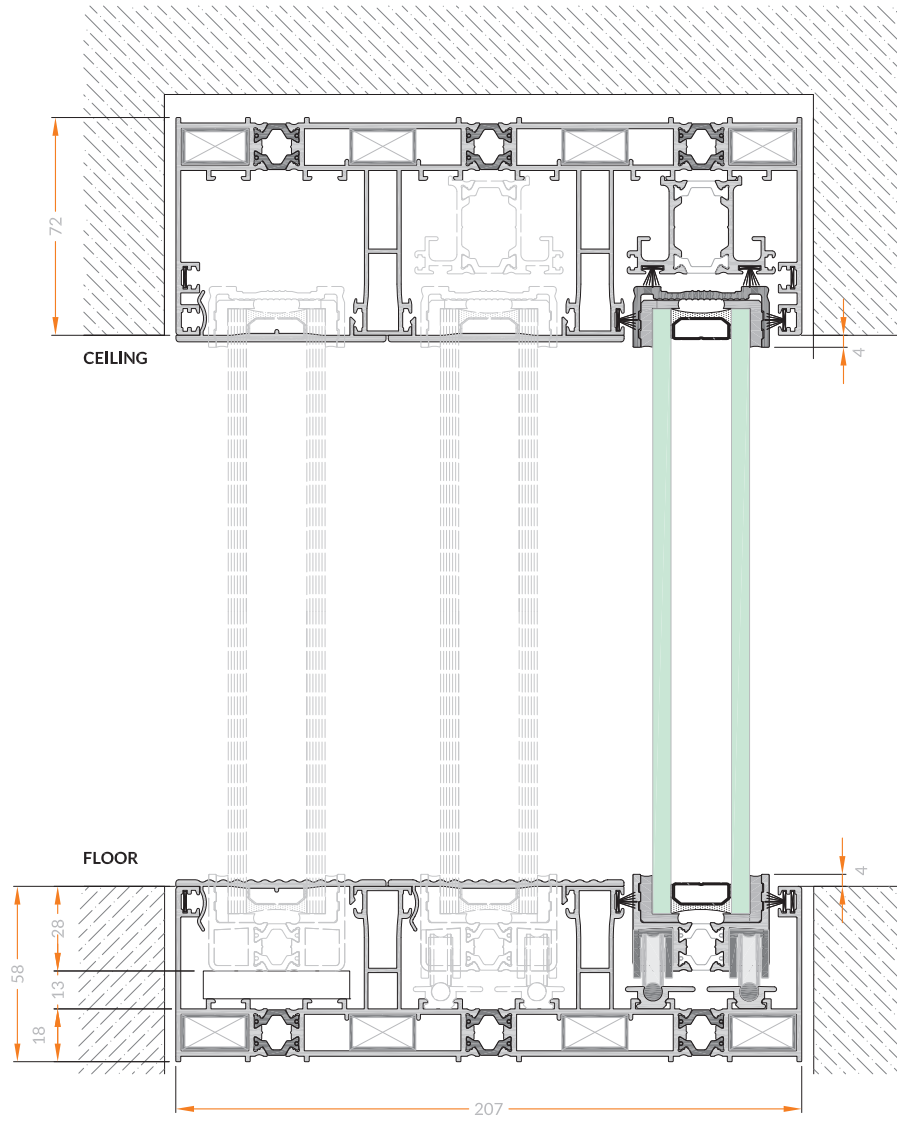

TRIPLE TRACK FRAME · S · S · F

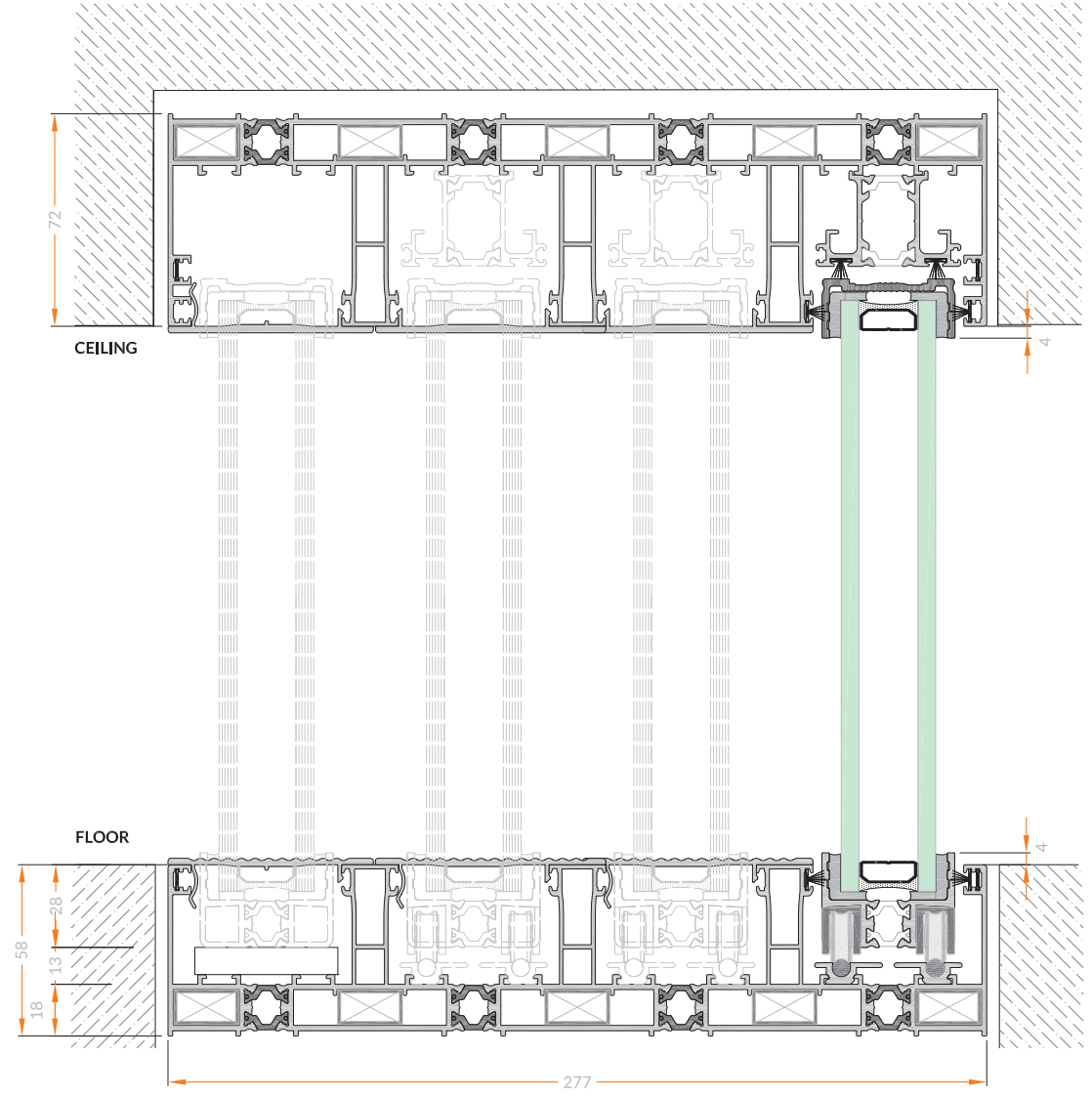

QUADRUPLE TRACK FRAME · S · S · S · F

OMICRON • LABYRINTH PROFILES

4.3

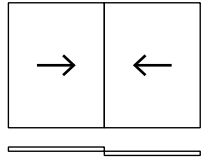

Standard sliding frames (different track)

A

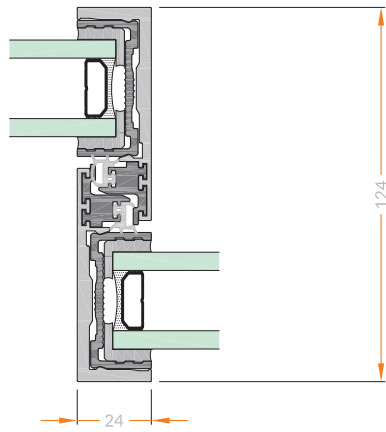

B

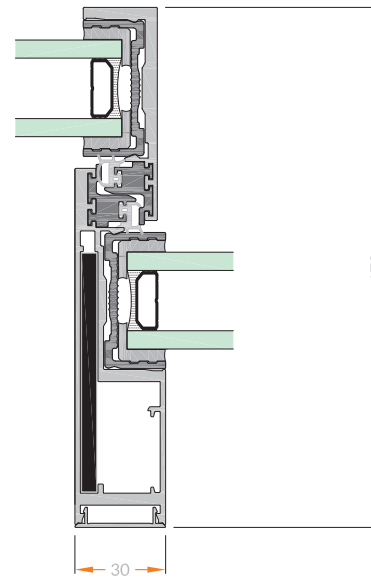

C

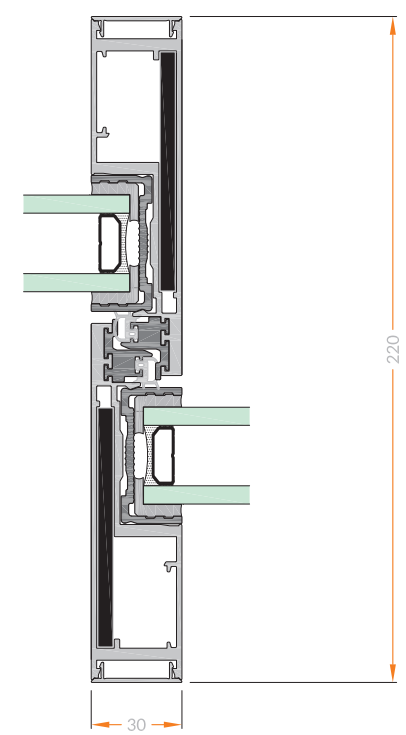

 Steel reinforcement when statically required

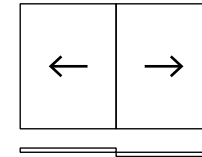

Sliding away
from each other
(different track)

4.3

E

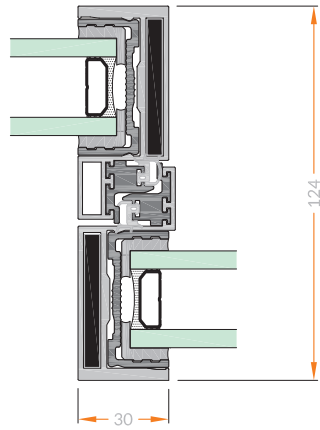

D

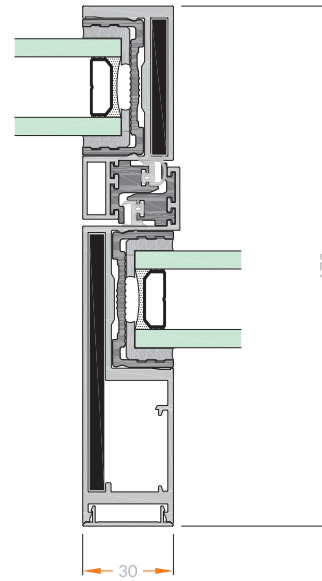

F

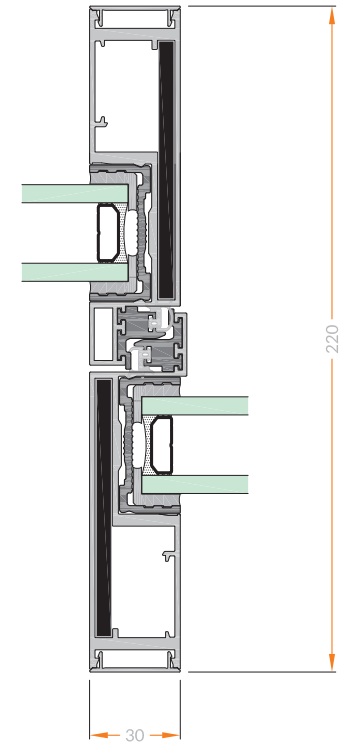

 Steel reinforcement
when statically required

OMICRON • GLASS COMBINATIONS (from 30mm - max 36mm)

4.4

Double Glass

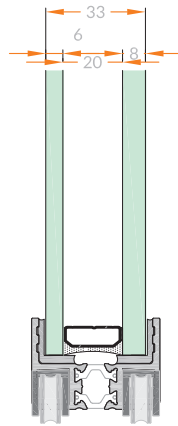
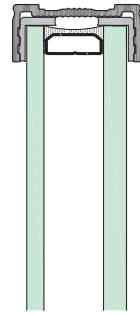

6 · 21 · 44.1
D = 35mm

Double Glass

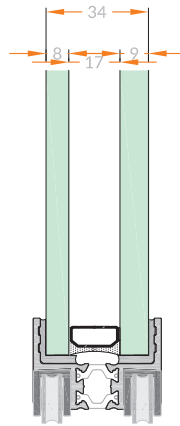
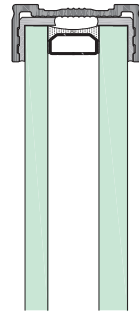

44.1 · 18 · 55.1
D = 36mm

Double Glass

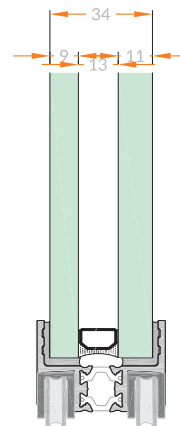
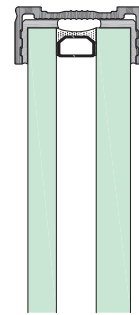

10 · 14 · 66.1
D = 36mm

Double Glass

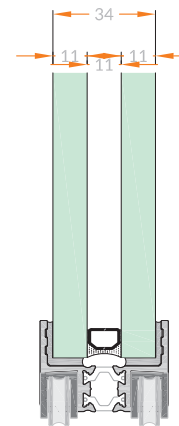
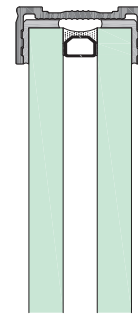

66.1 · 12 · 66.1
D = 36mm

VERTICAL SECTIONS

HEAT MIRROR GLASS

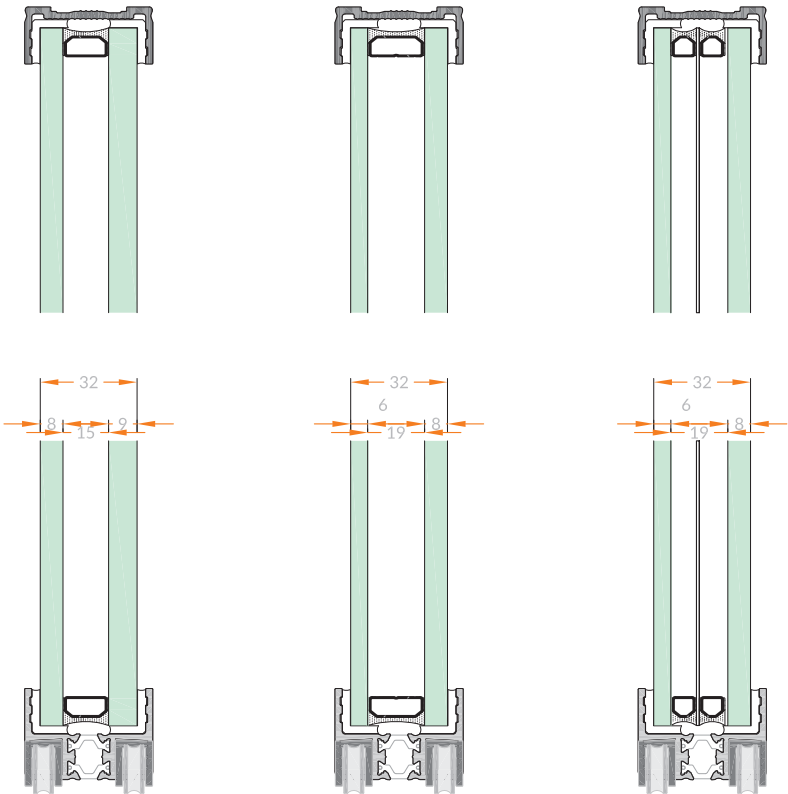

44.1 · 16 · 10
D = 34mm

6 · 20 · 44.1
D = 34mm

6 · 9 · HM · 9 · 44.1
D = 34mm

VERTICAL SECTIONS

5.1

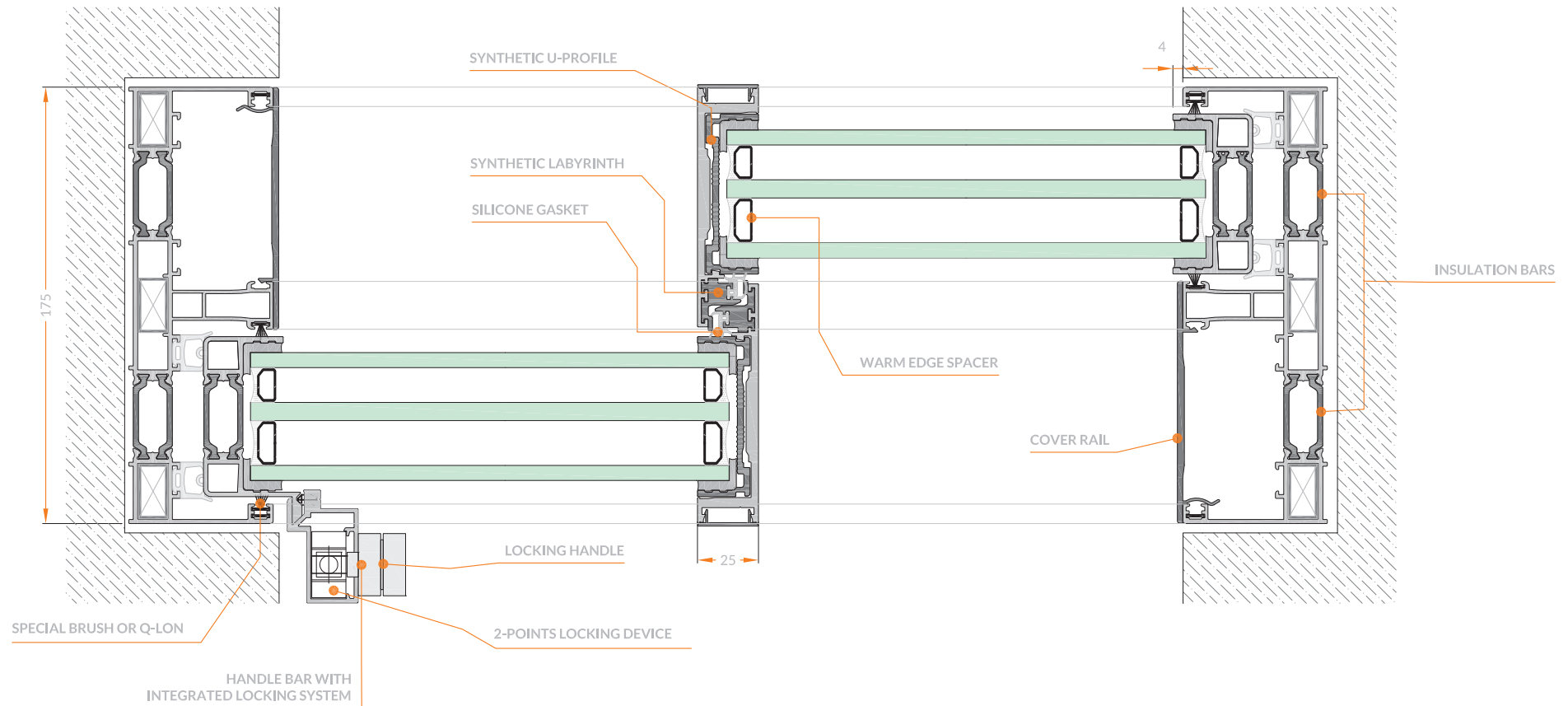

HORIZONTAL SECTION

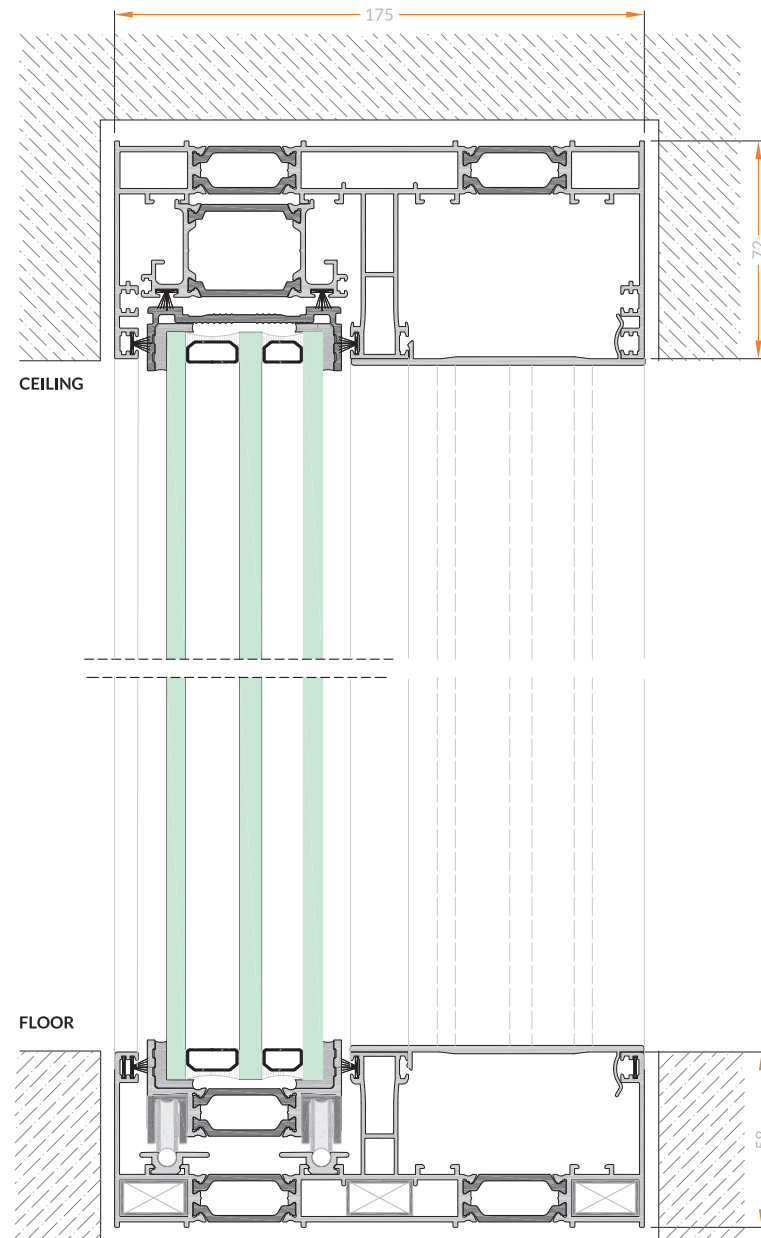

CEILING

FLOOR

VERTICAL SECTION

5.2

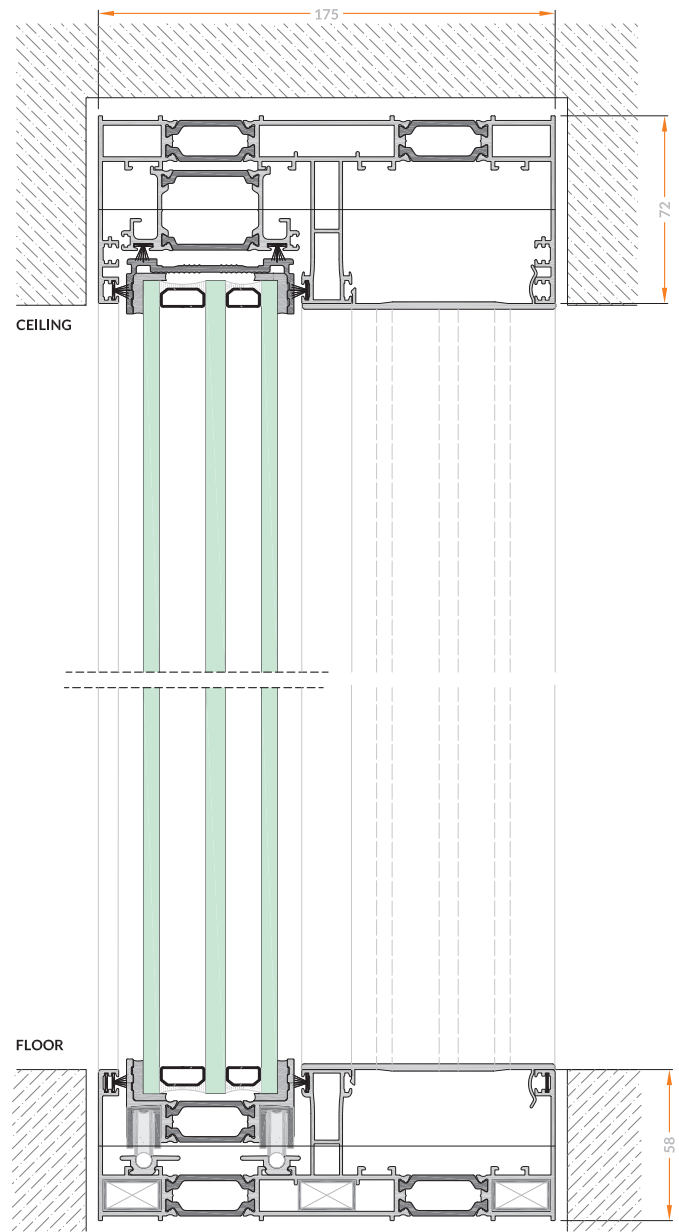
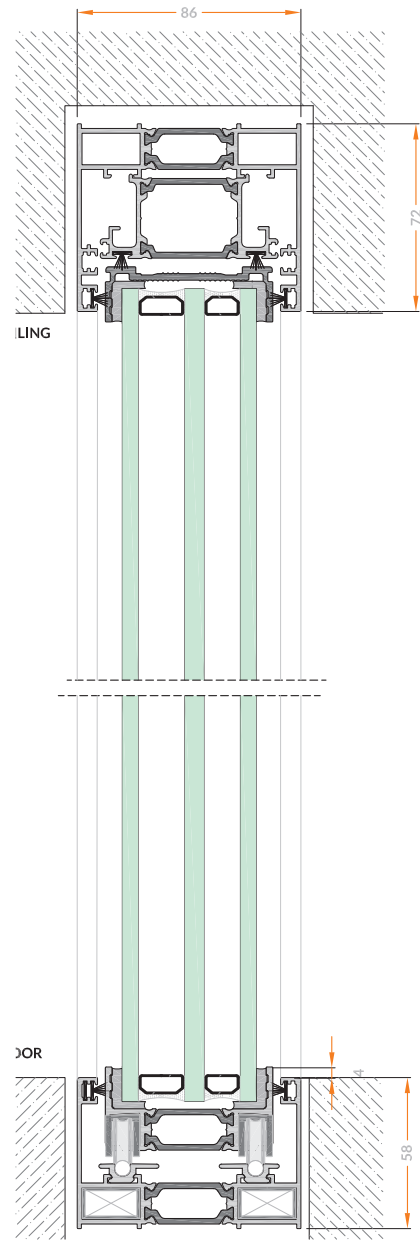

VERTICAL SECTIONS

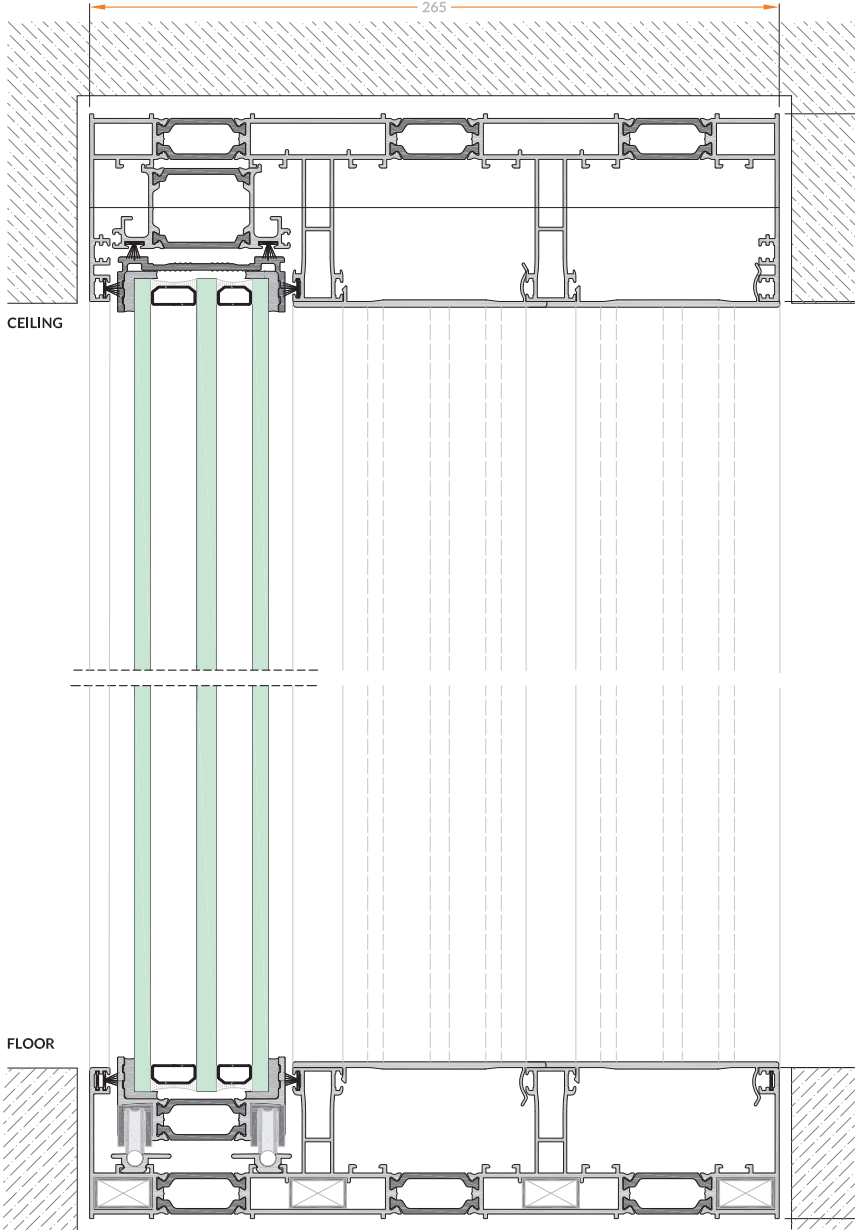

VERTICAL SECTION

5.3

A

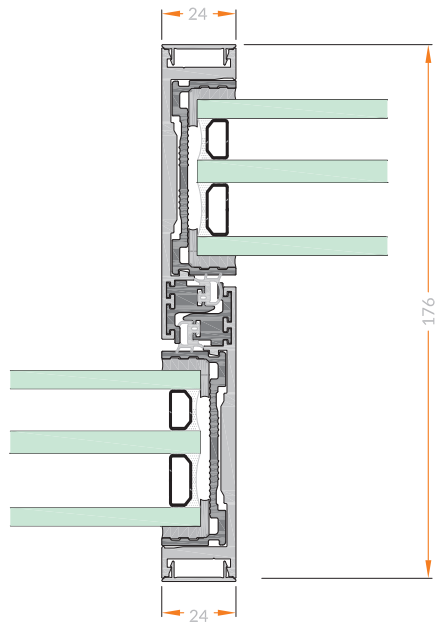

B

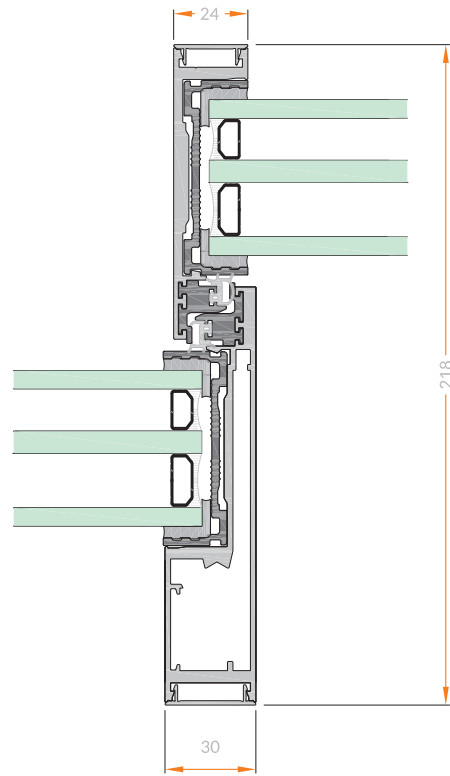

C

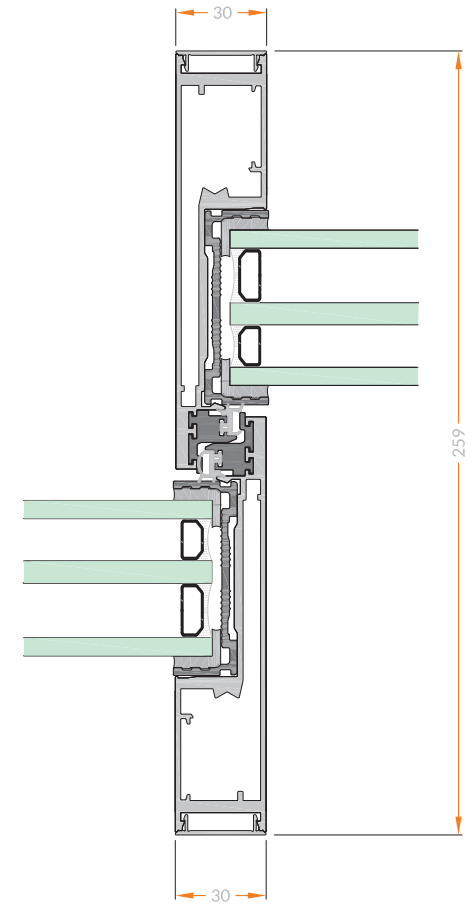

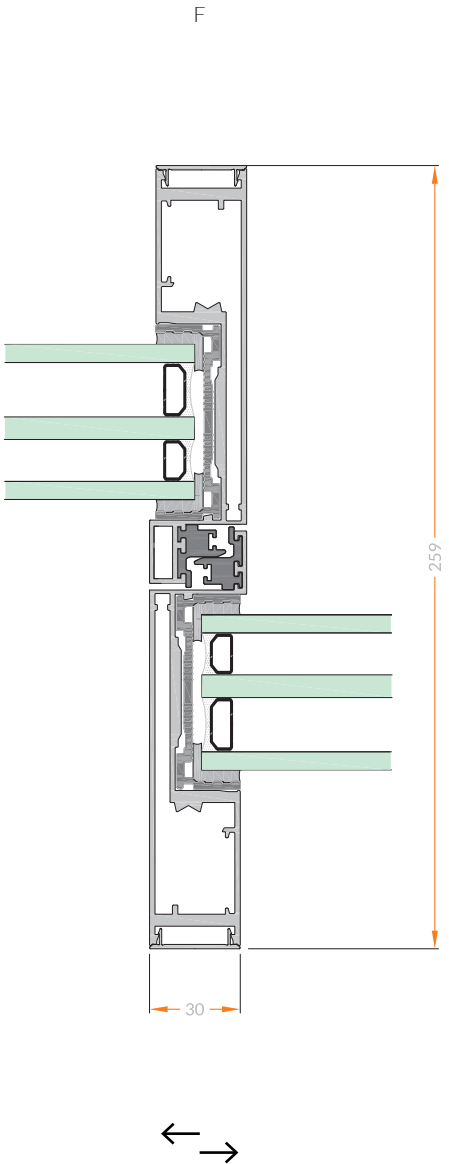
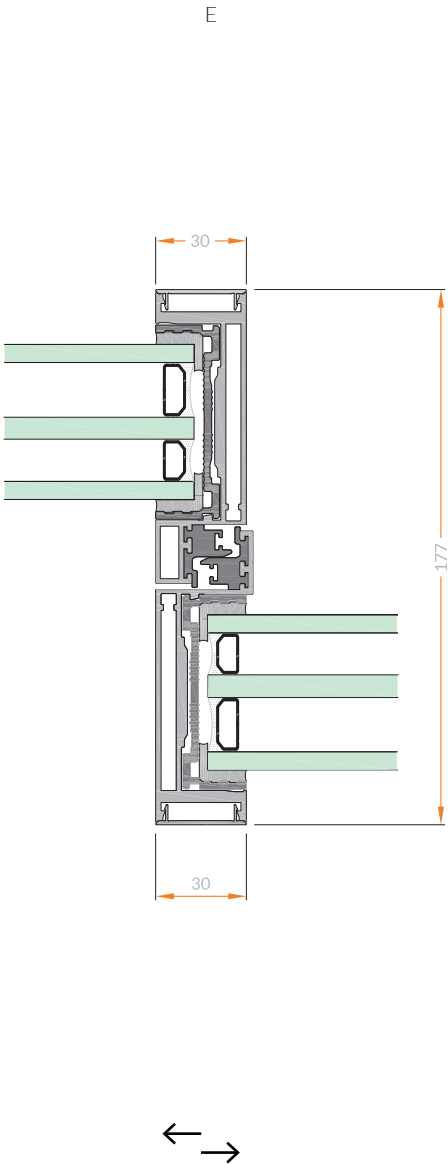
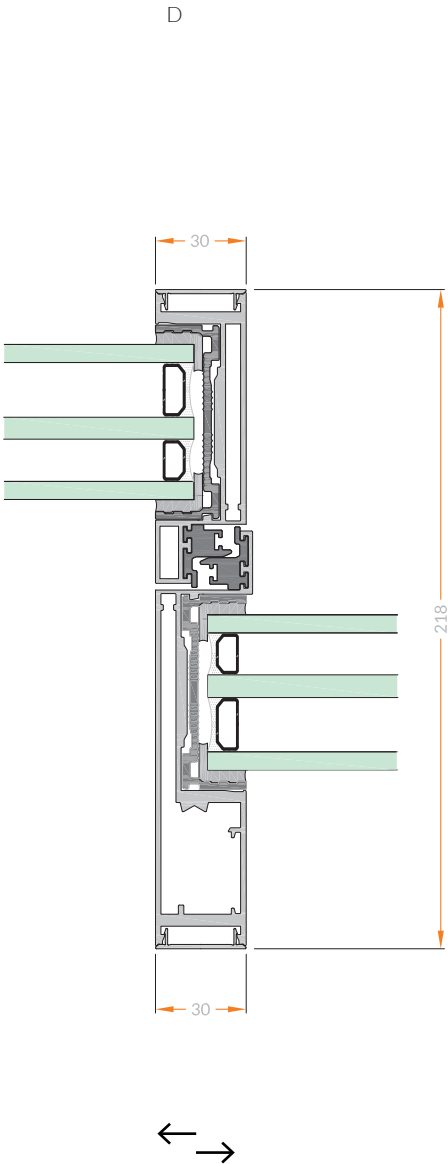

ΩMEGA • GLASS COMBINATIONS (from 49mm - max 54mm)

5.4

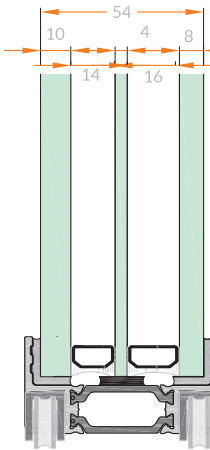
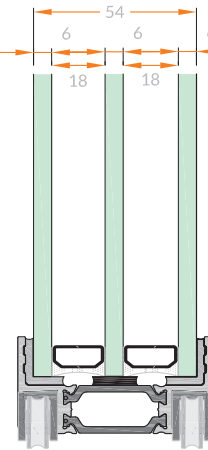
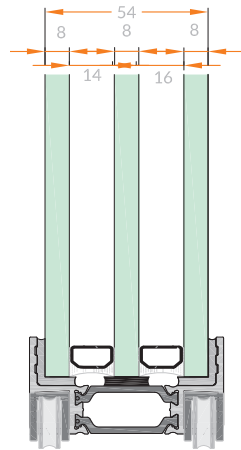
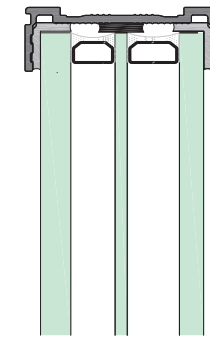
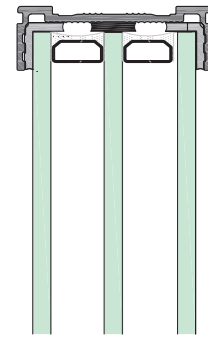
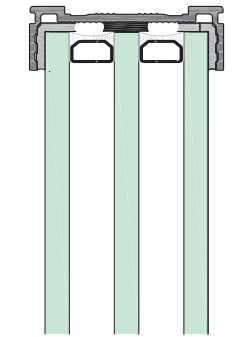

8 · 14 · 8 · 16 · 8
D = 54mm

6 · 18 · 6 · 18 · 6
D = 54mm

10 · 14 · 4 · 14 · 8
D = 54mm

VERTICAL SECTIONS

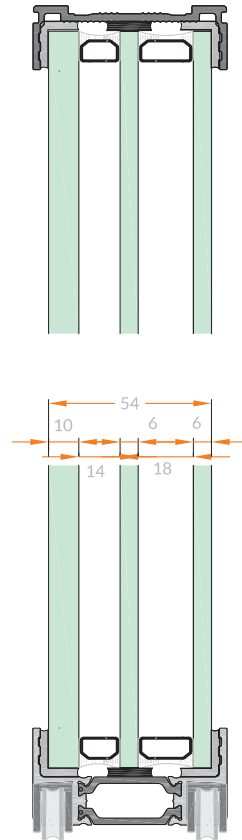

10 · 14 · 6 · 18 · 6
D = 54mm

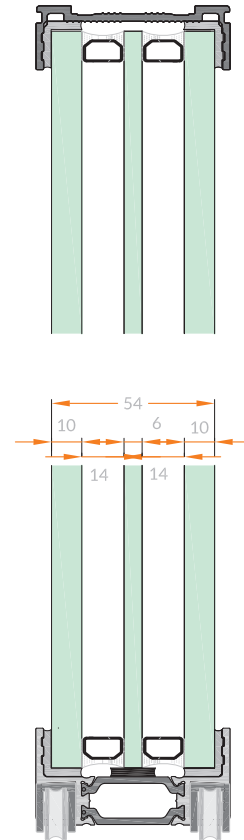

10 · 14 · 6 · 14 · 10
D = 54mm

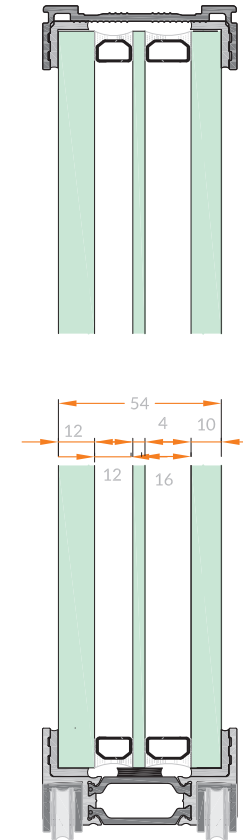

12 · 12 · 4 · 16 · 10
D = 54mm

HANDLE

6

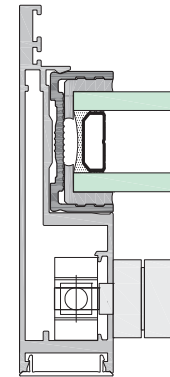
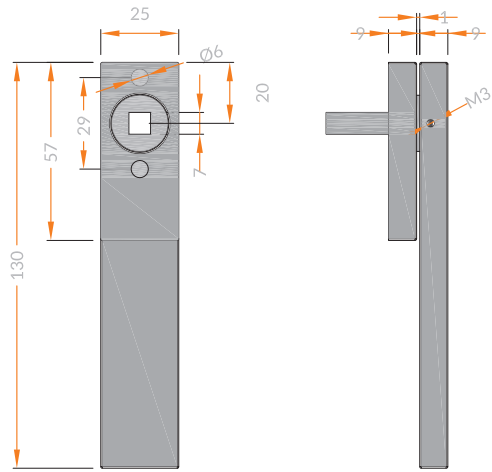
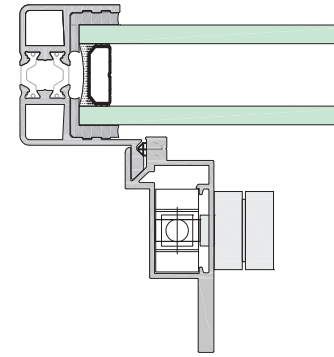
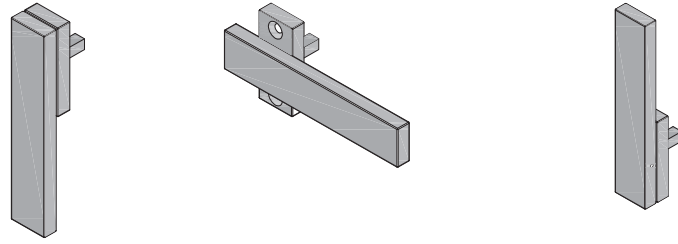

INSTALLATION MODES

7.1

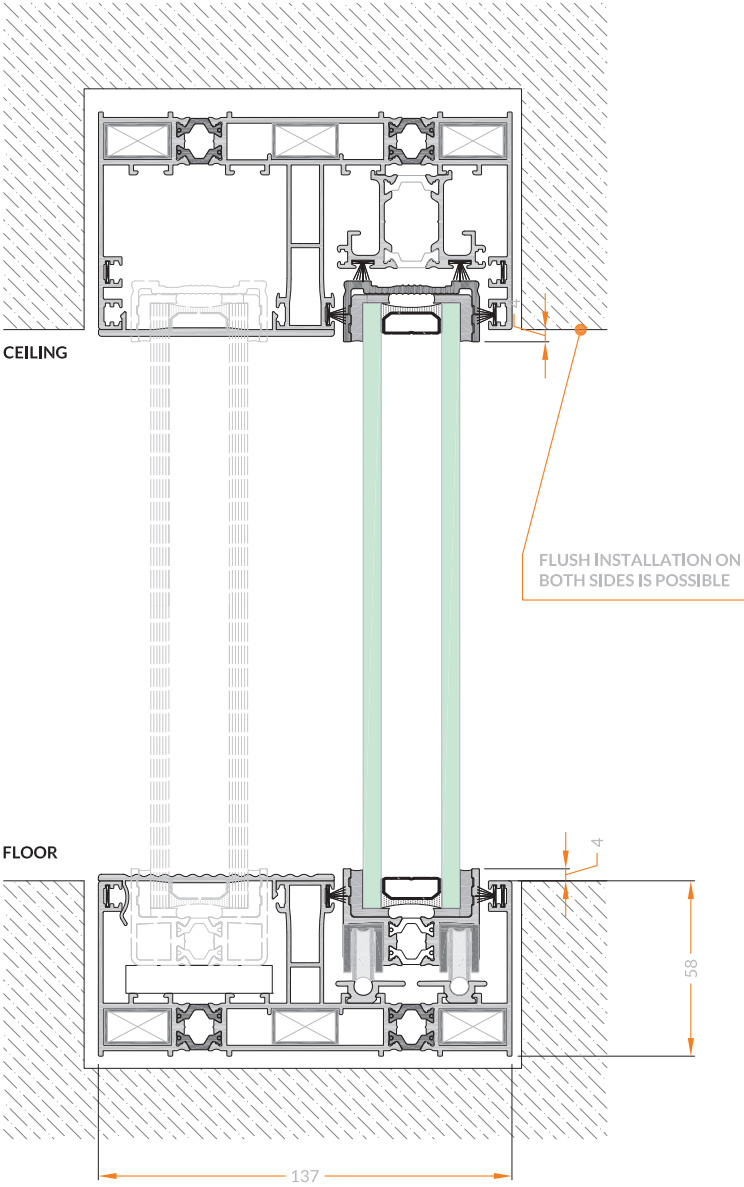

VERTICAL SECTION

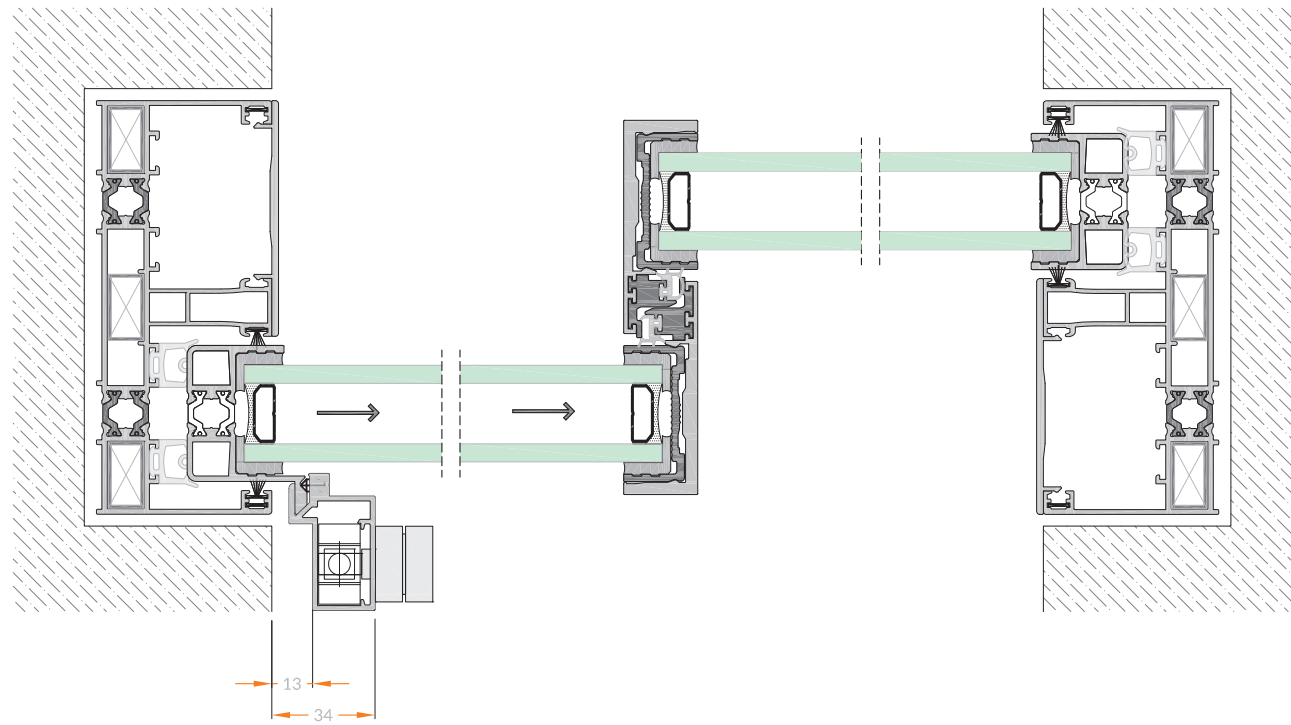

HORIZONTAL SECTION

MAIN FRAME SOLUTIONS

8

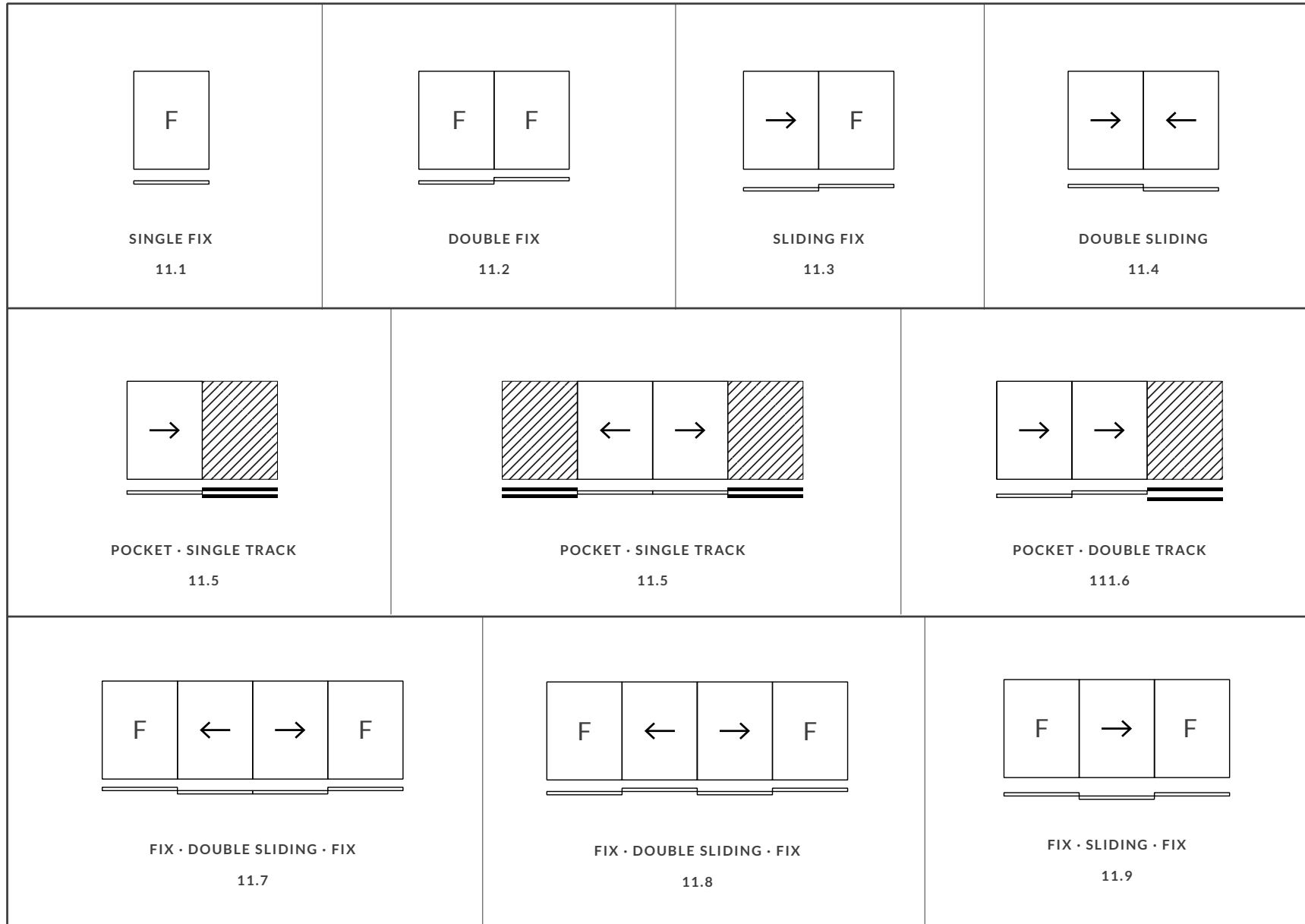

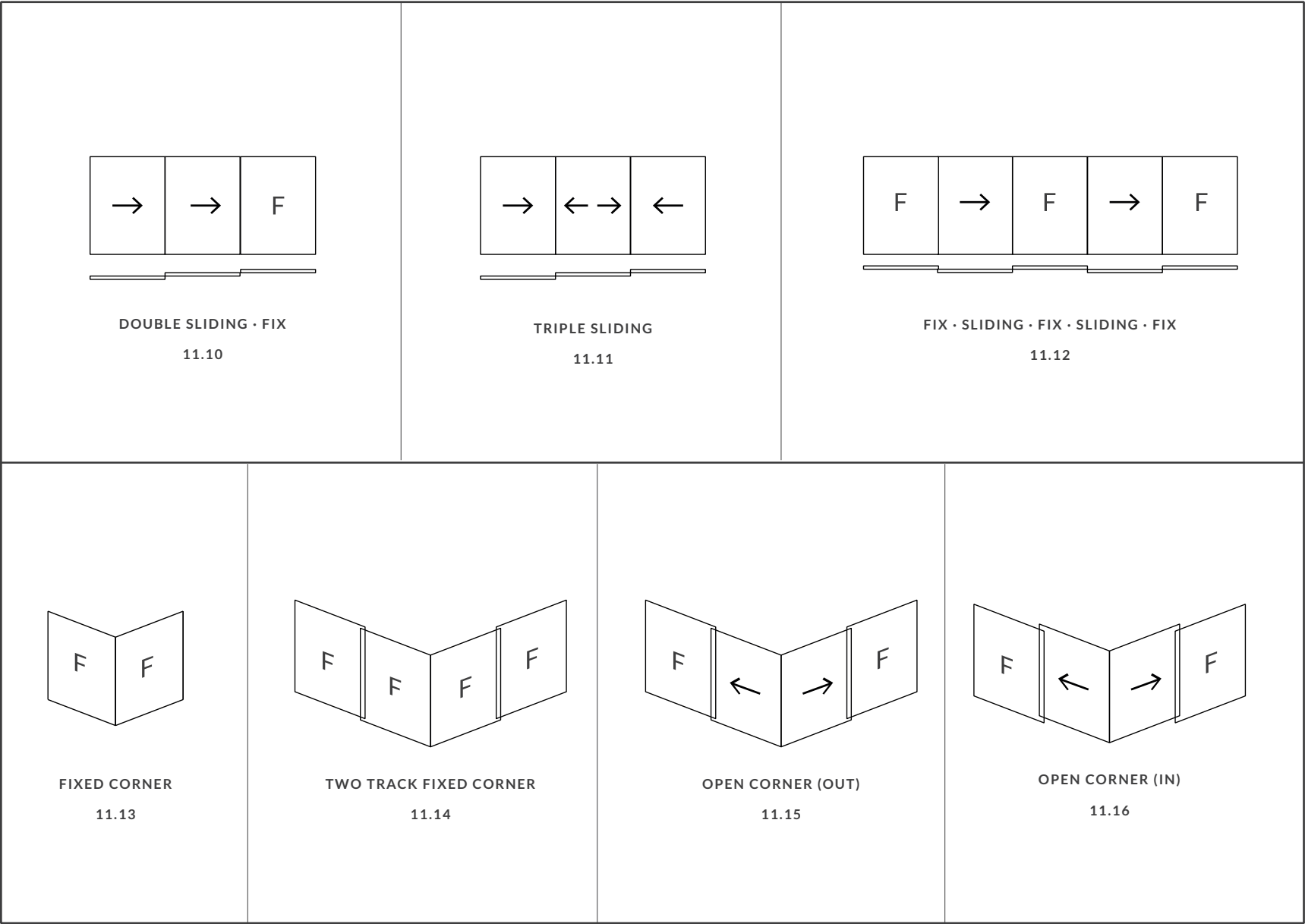

FIX FRAME

8.1

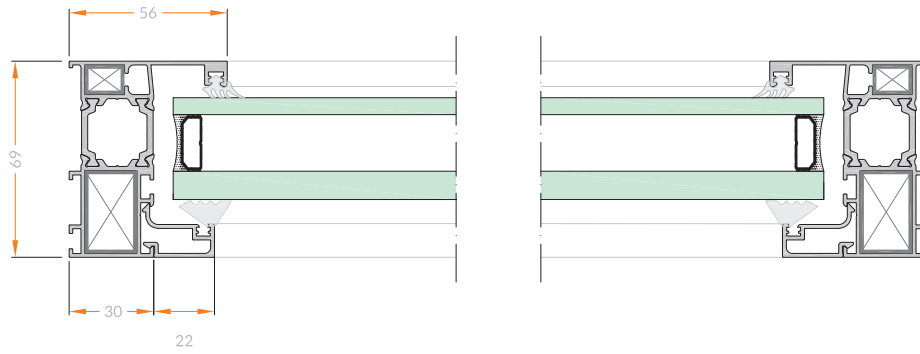

HORIZONTAL SECTION

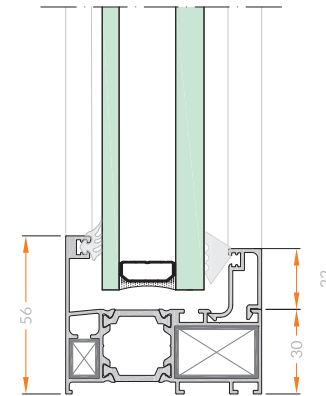
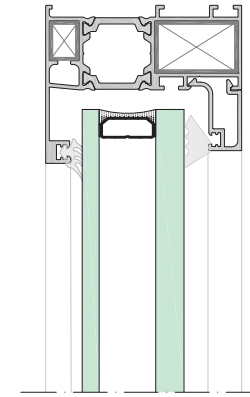

VERTICAL SECTION

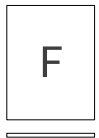

DOUBLE FIX FRAME

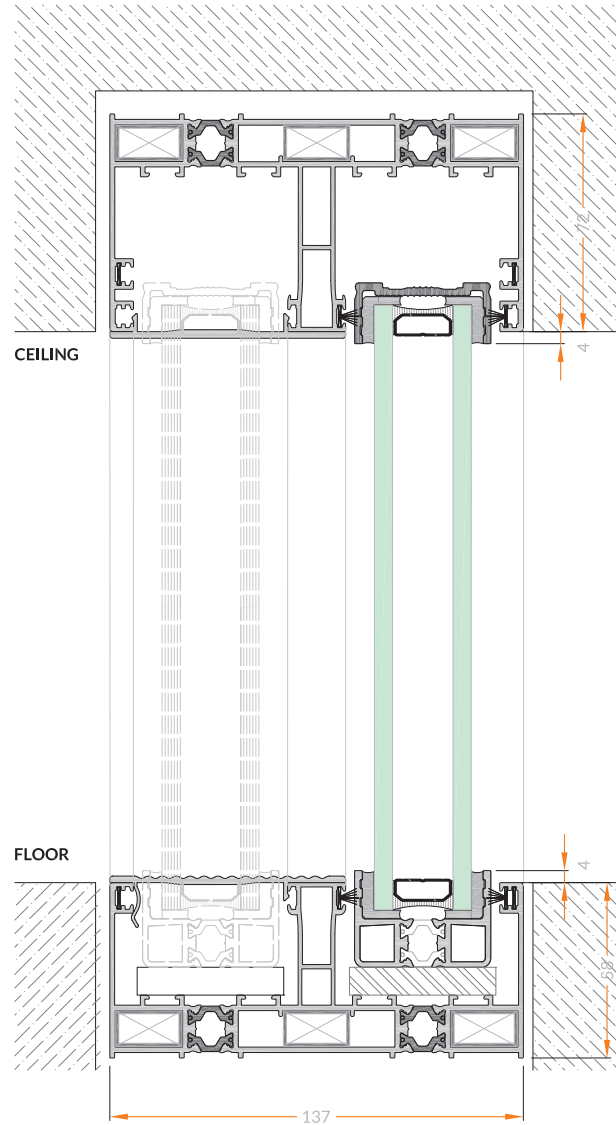

VERTICAL SECTION

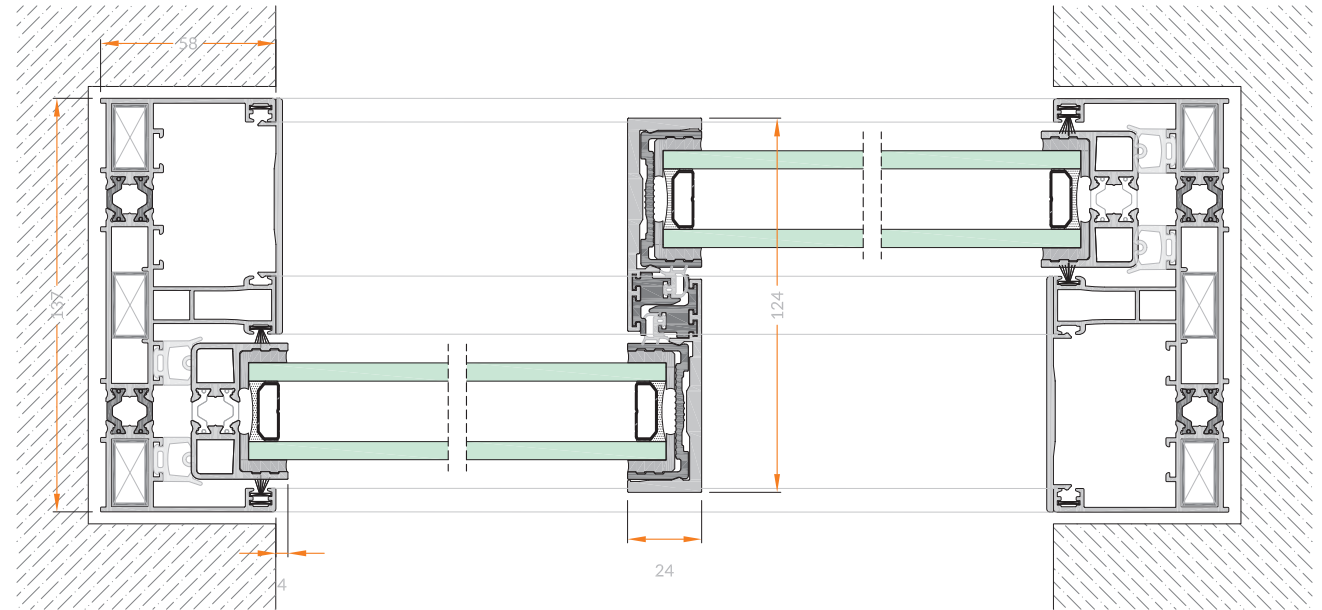

HORIZONTAL SECTION



DOUBLE SLIDING FRAME

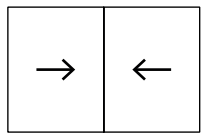
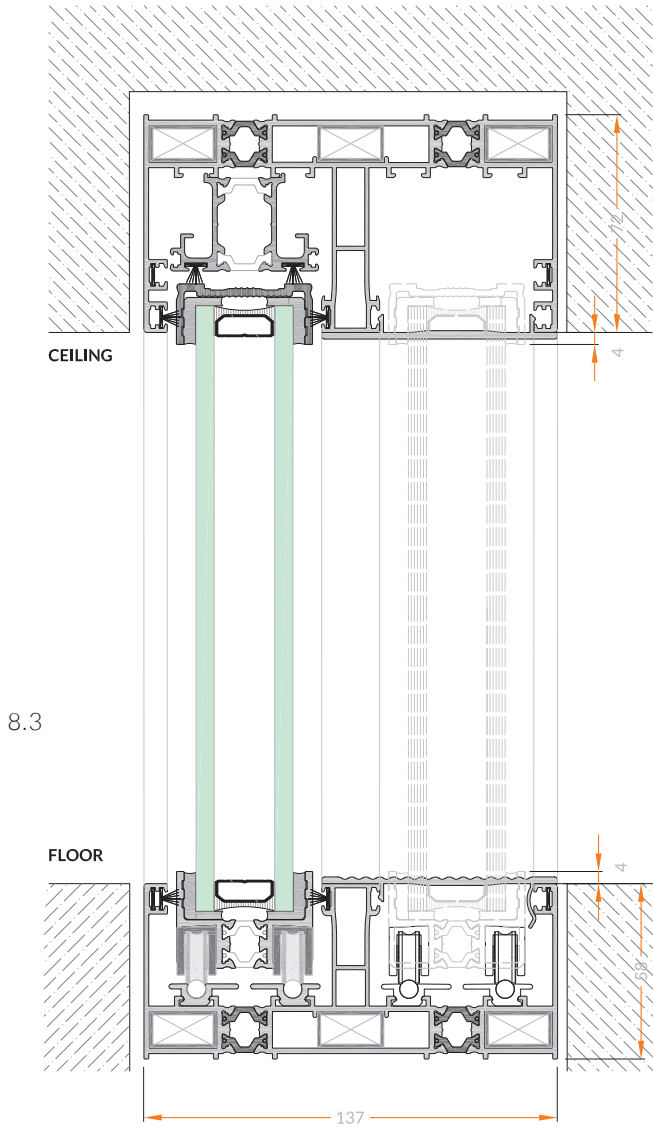

VERTICAL SECTION

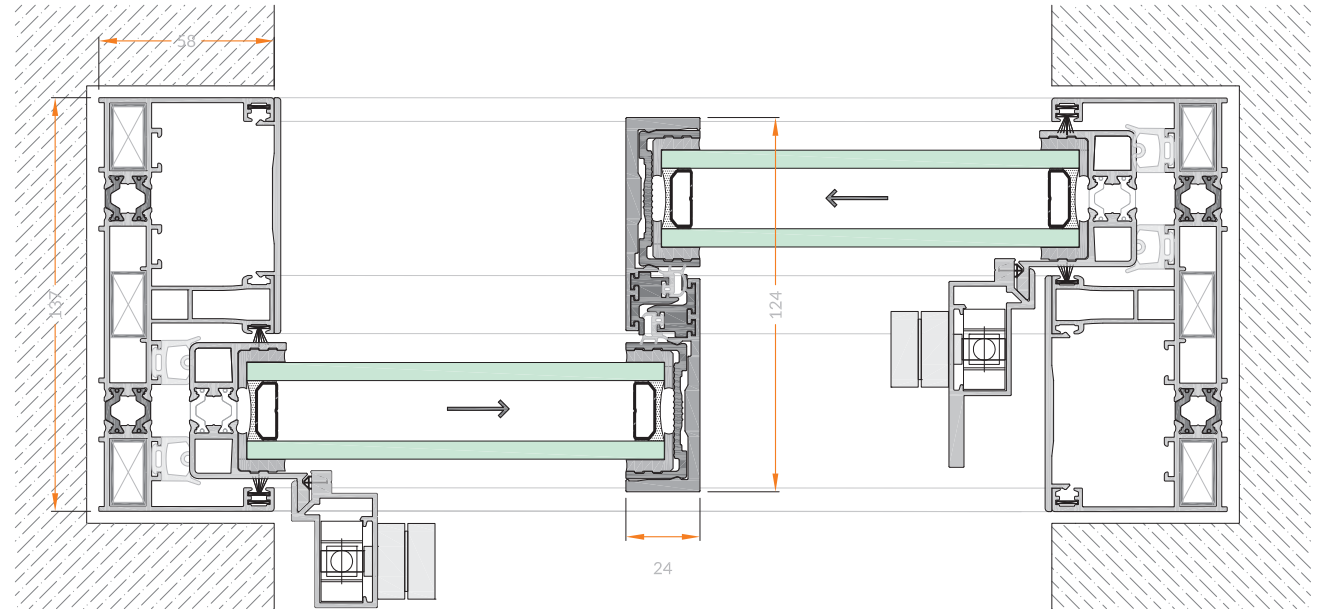

HORIZONTAL SECTION

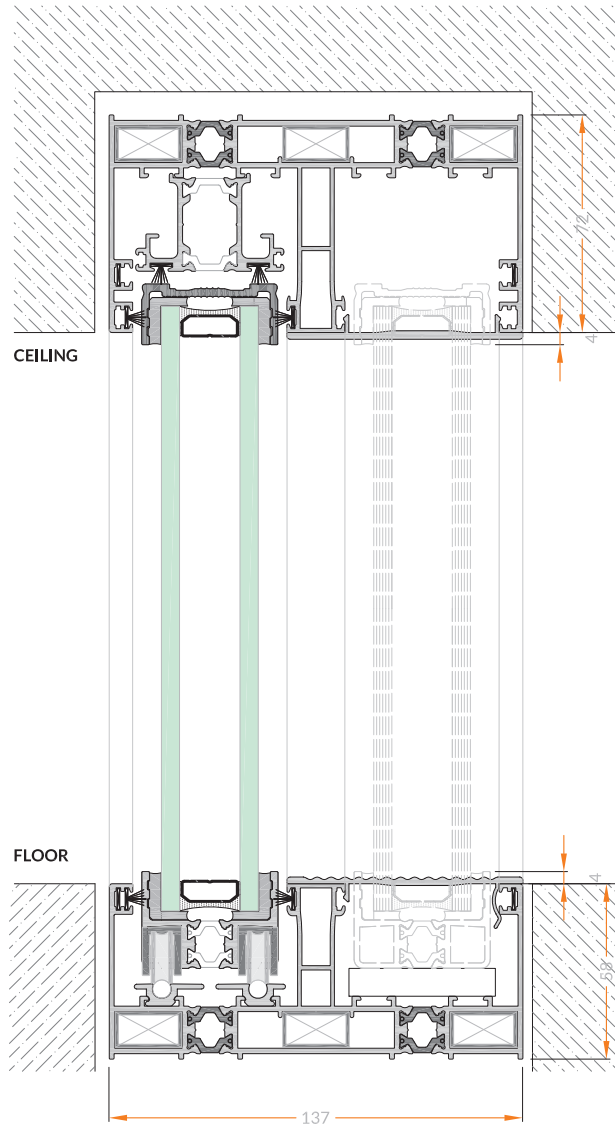

VERTICAL SECTION

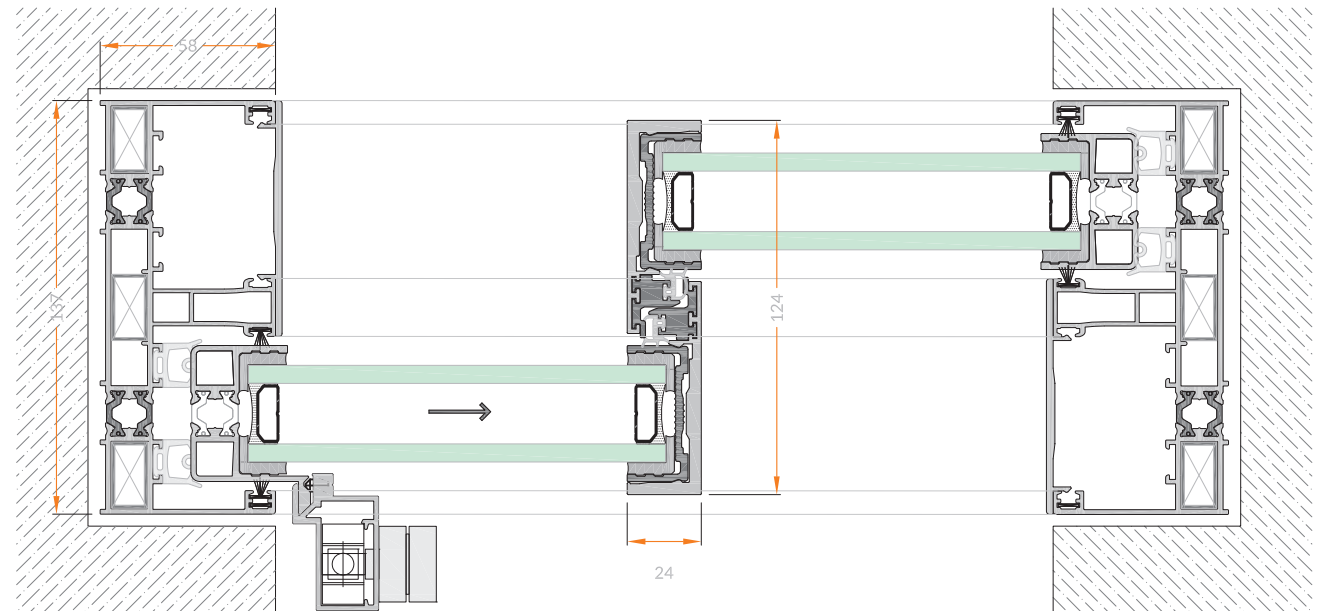

HORIZONTAL SECTION

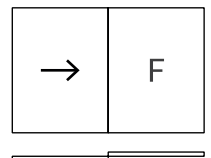

POCKET WINDOWS · SINGLE TRACK

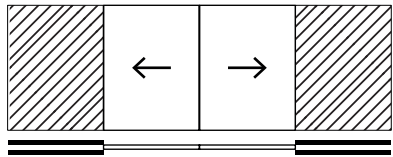
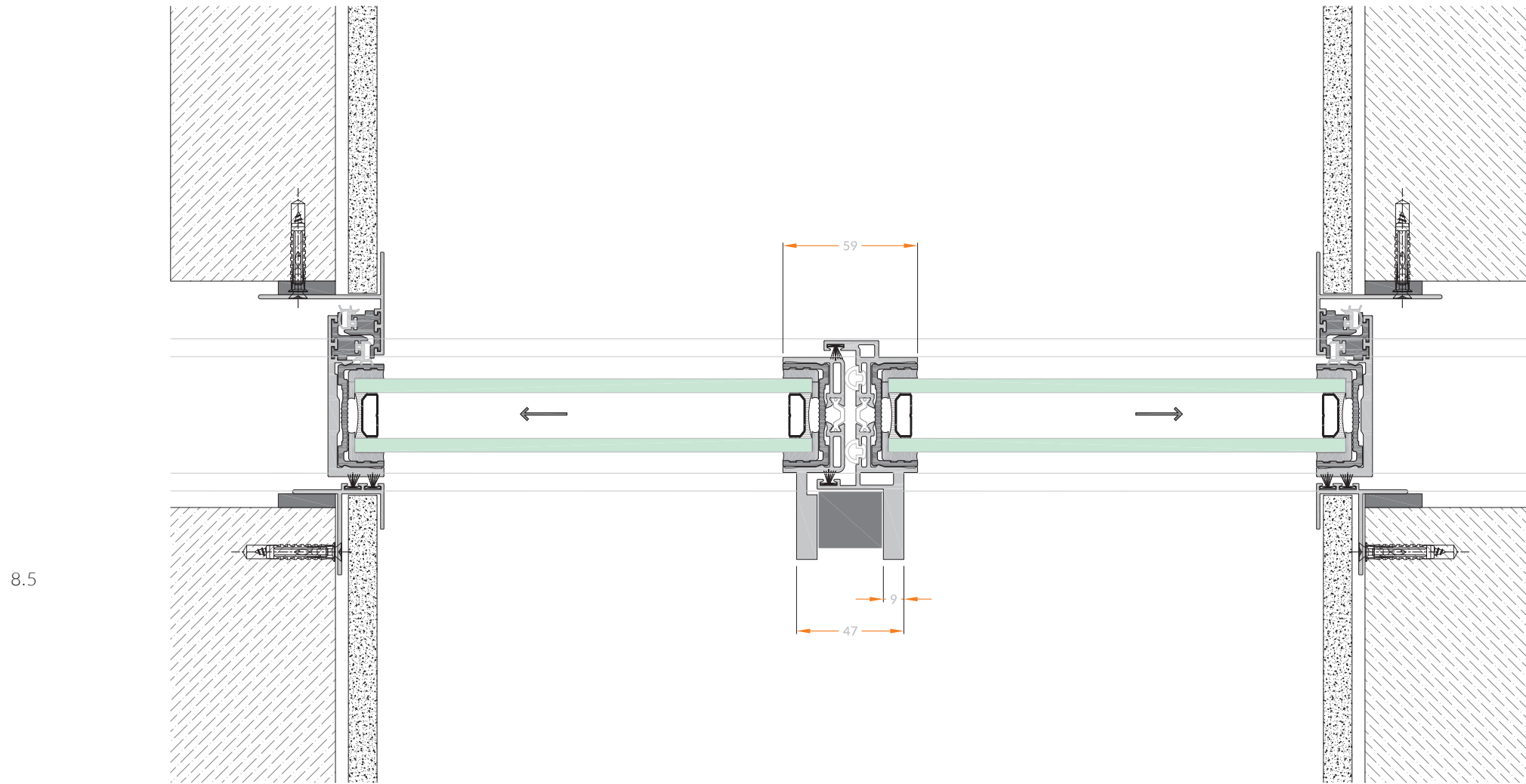

HORIZONTAL SECTION · CLOSED

POCKET WINDOWS · SINGLE TRACK

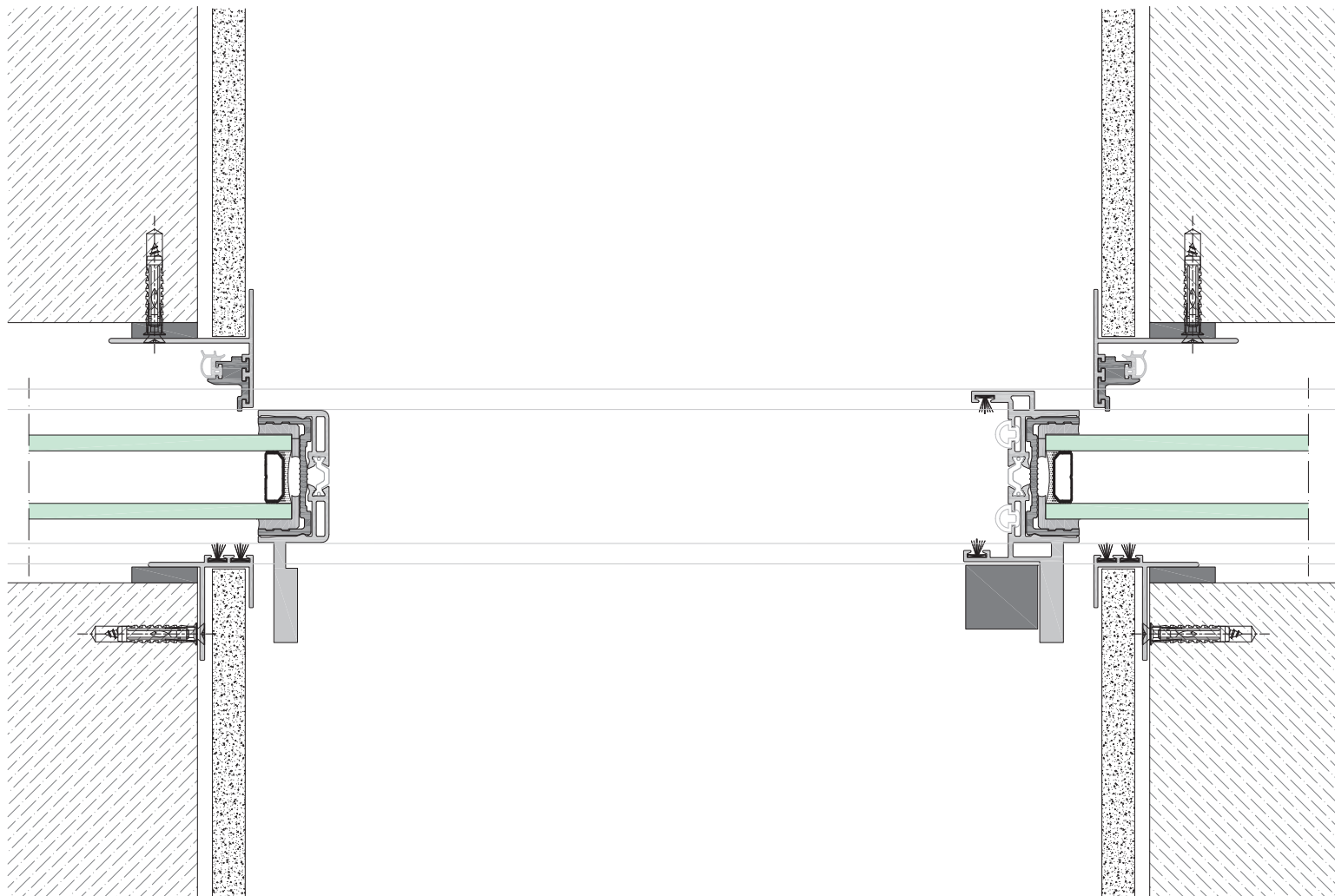

HORIZONTAL SECTION · OPEN

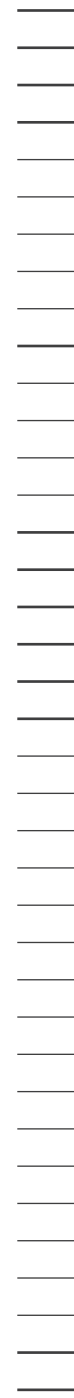
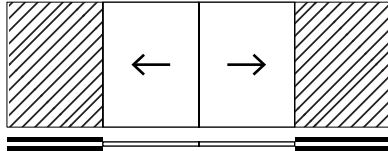

POCKET WINDOWS · DOUBLE TRACK

8.6

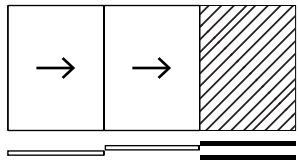
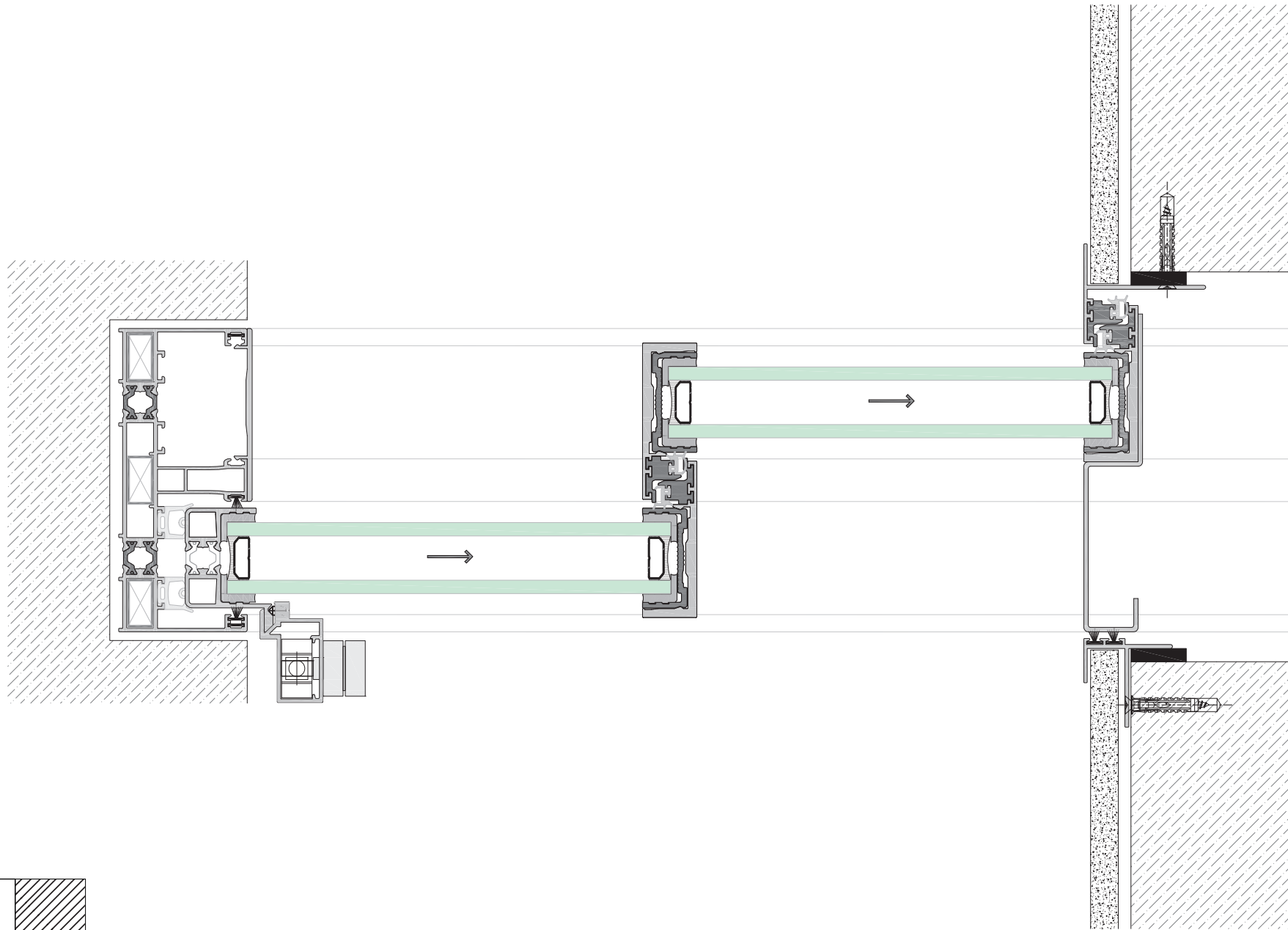

HORIZONTAL SECTION · OPEN

POCKET WINDOWS · DOUBLE TRACK

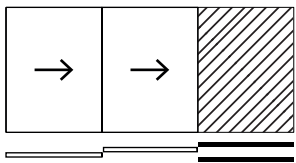
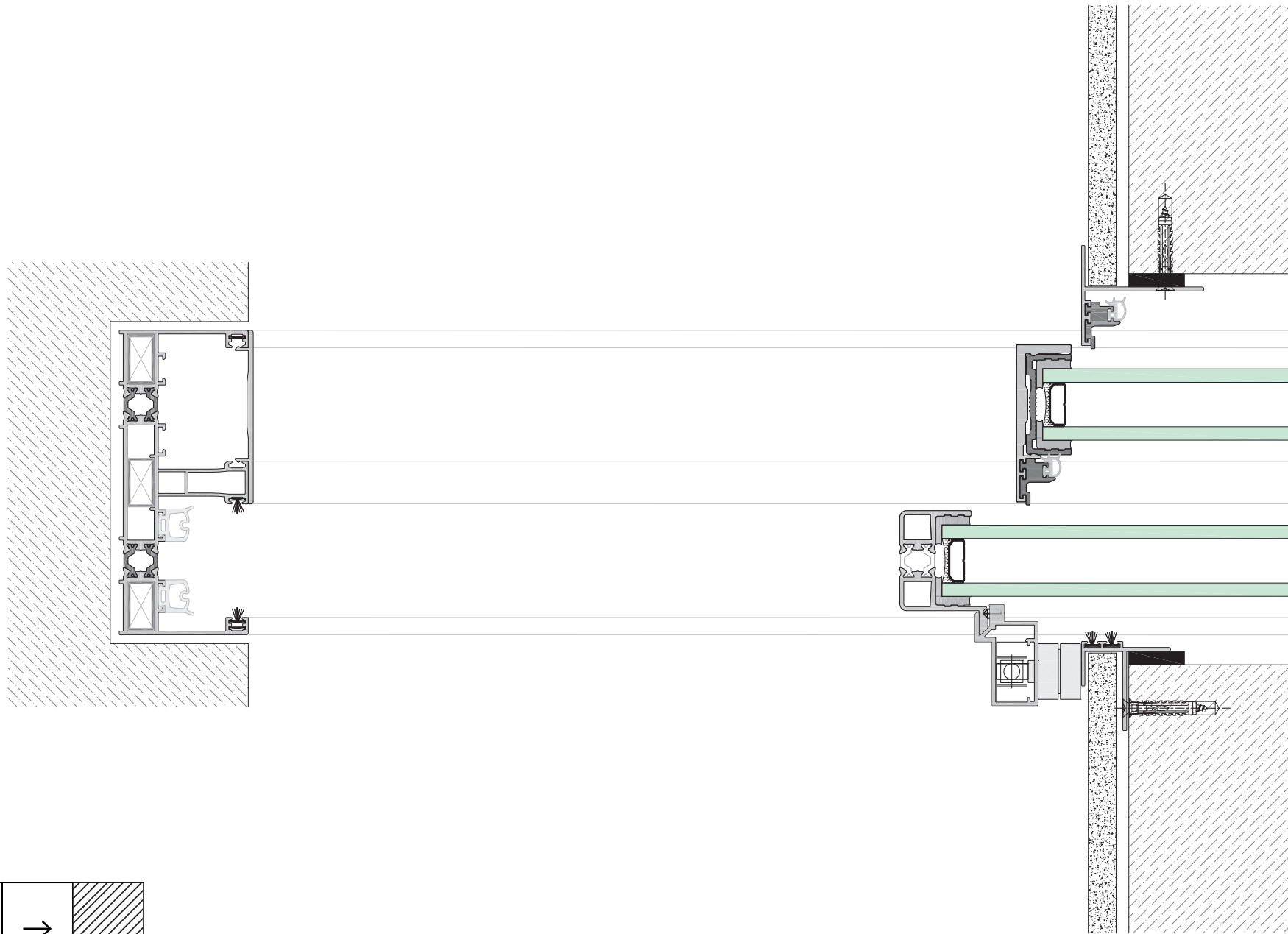

HORIZONTAL SECTION · CLOSED

FIX · DOUBLE SLIDING · FIX (ALTERNATE)

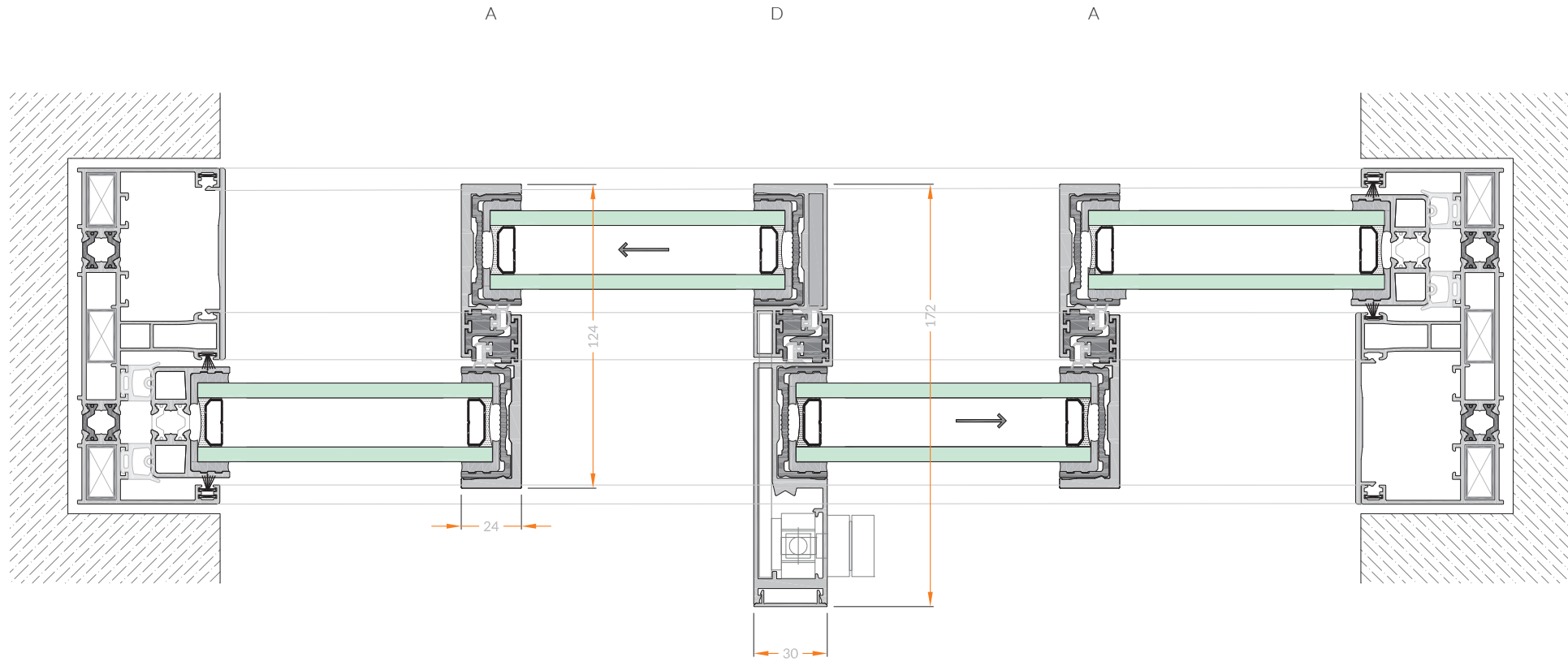

8.7

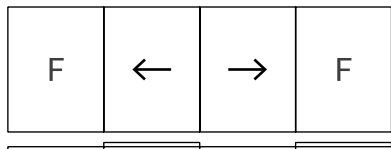

4-POINT LOCKING DEVICE UNDER DEVELOPMENT

FIX · DOUBLE SLIDING IN THE SAME TRUCK · FIX

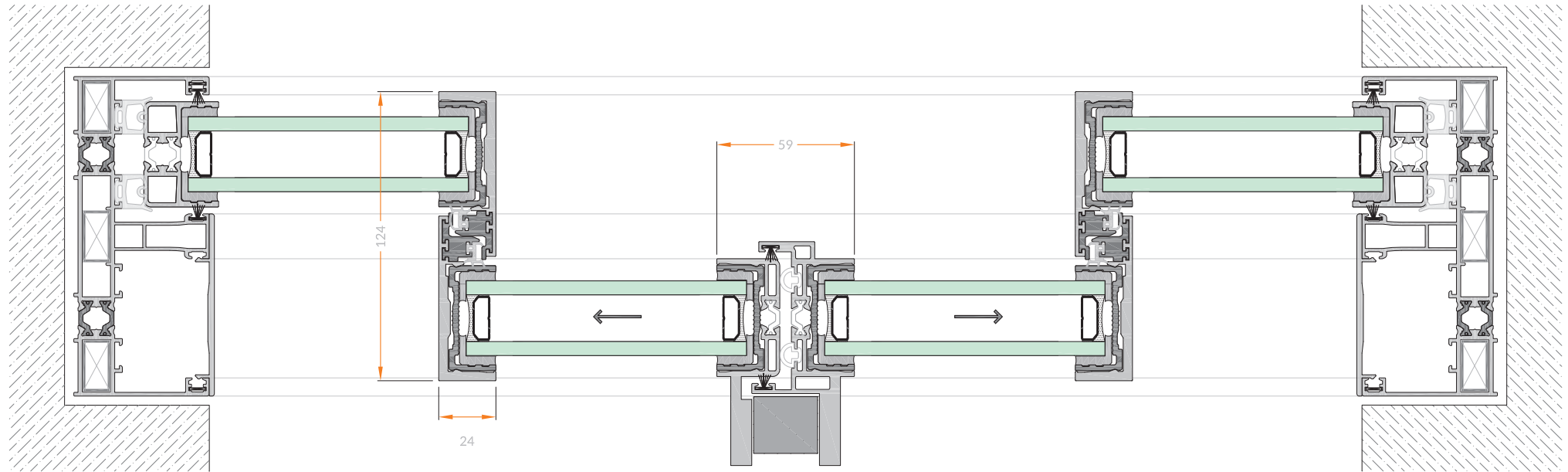

HORIZONTAL SECTION

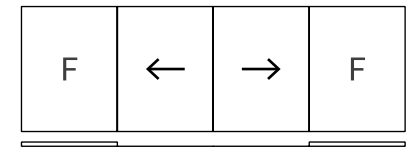

FIX · SLIDING · FIX

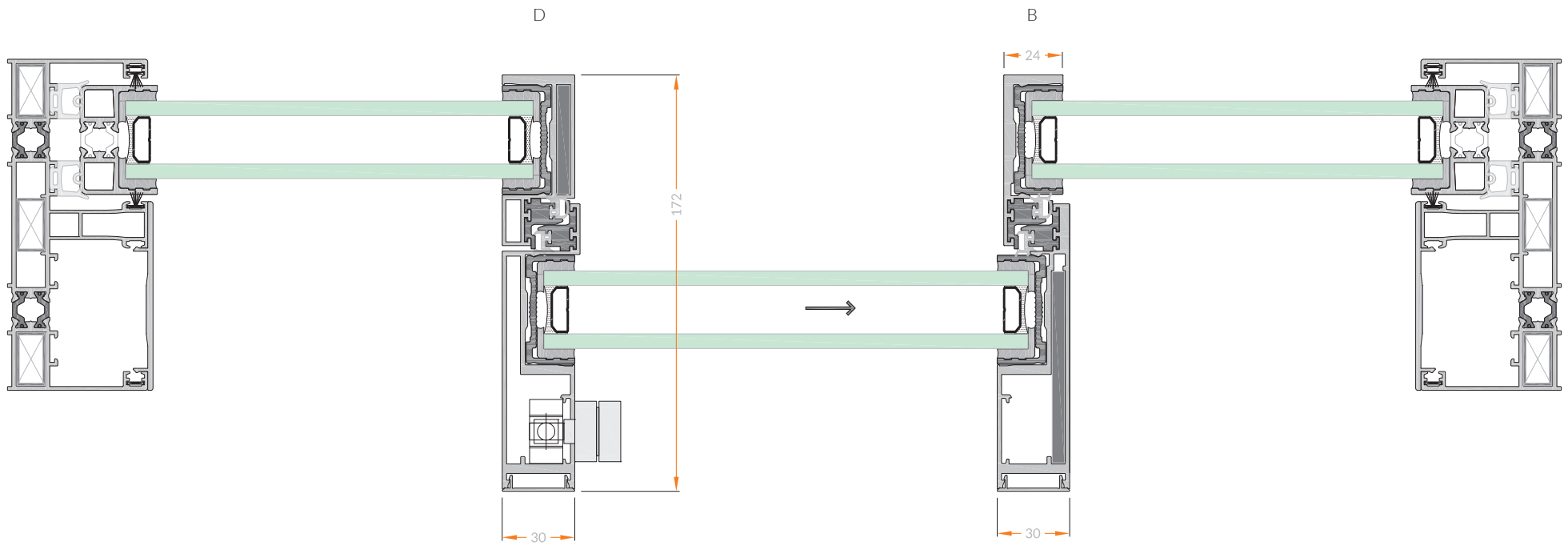

8.9

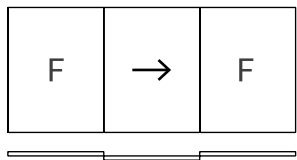

HORIZONTAL SECTION

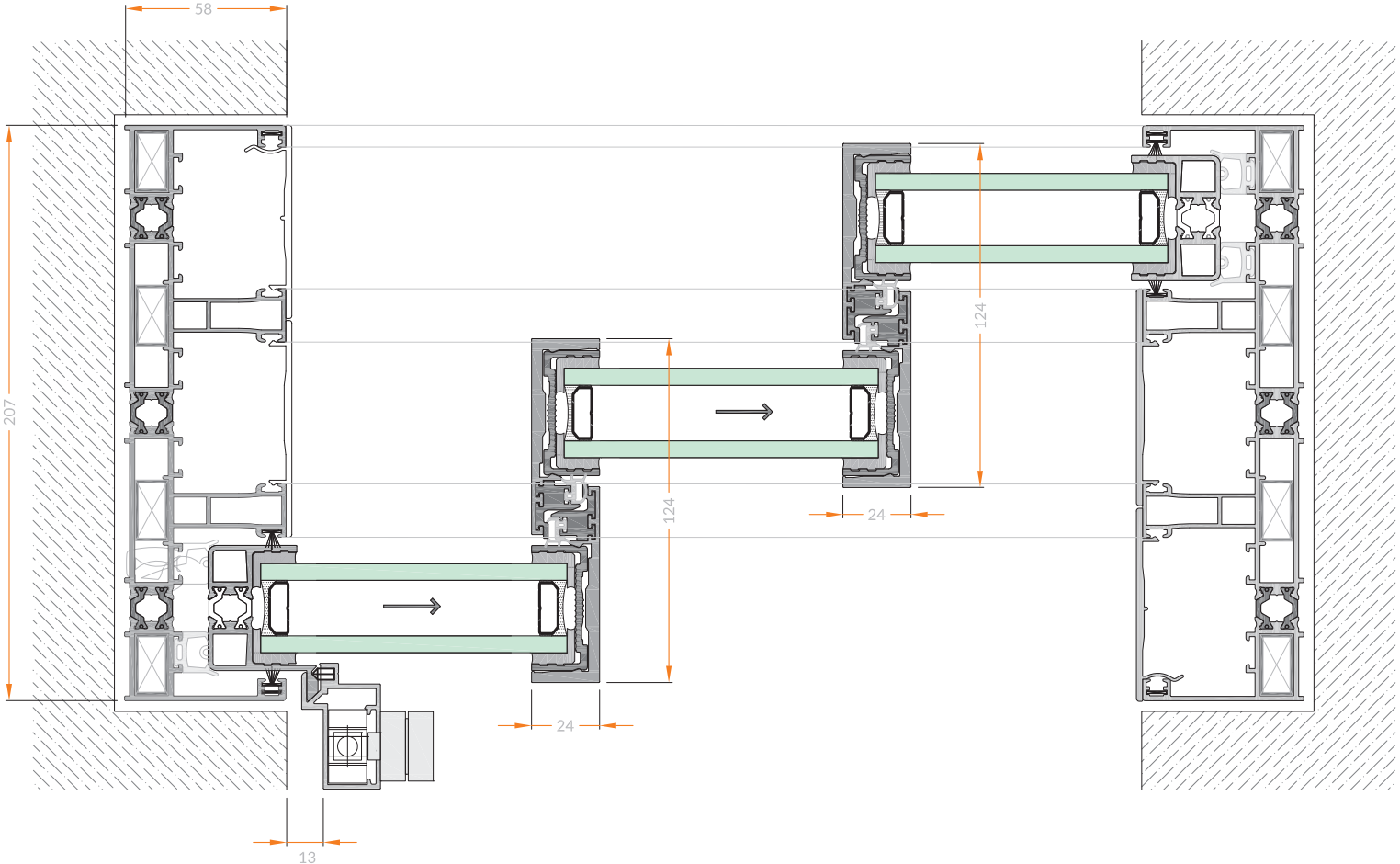

HORIZONTAL SECTION

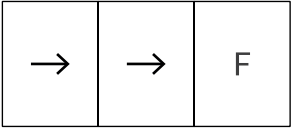

TRIPLE SLIDING

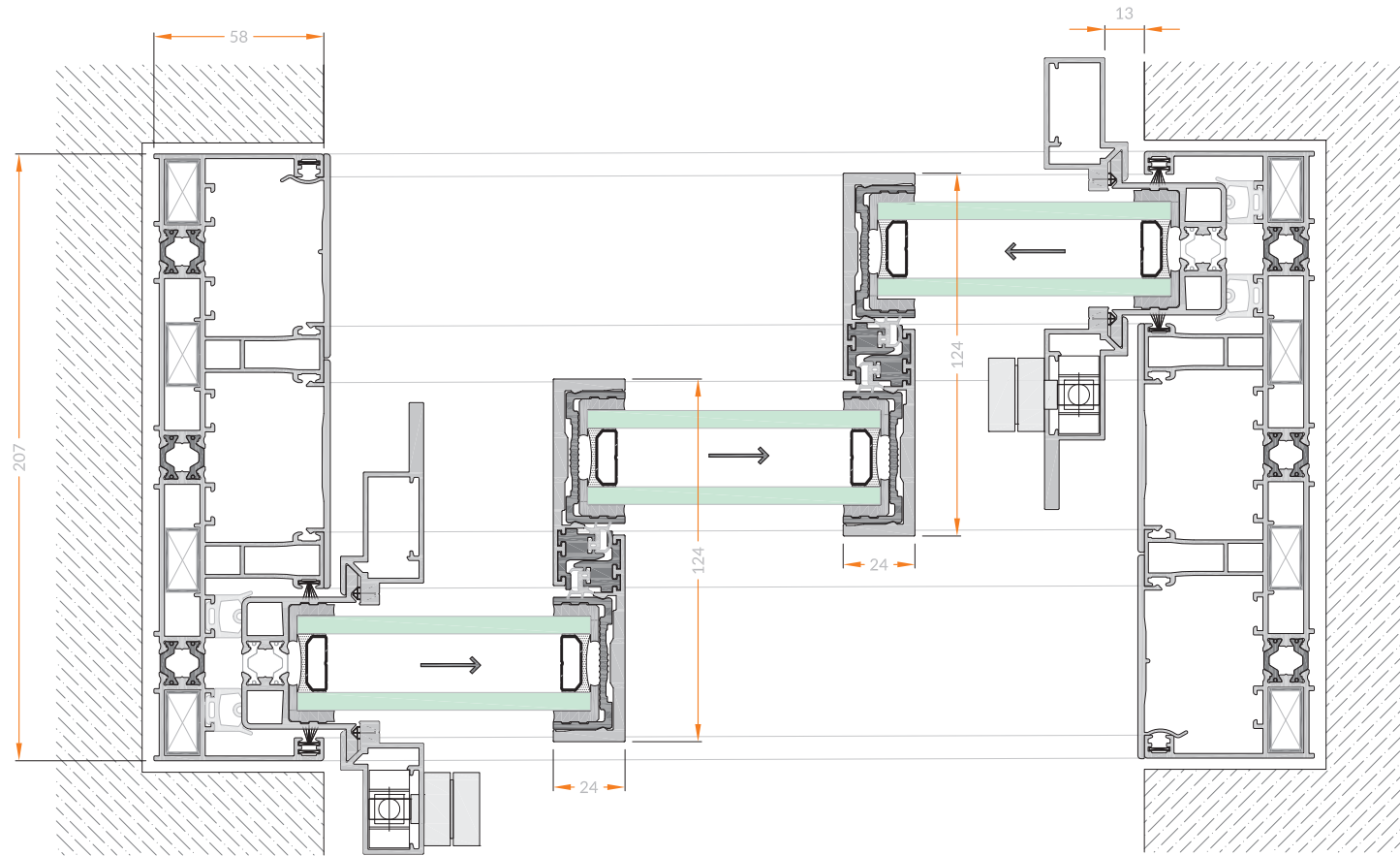

8.11

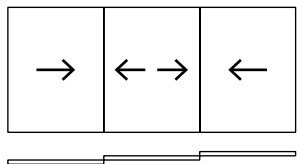

HORIZONTAL SECTION

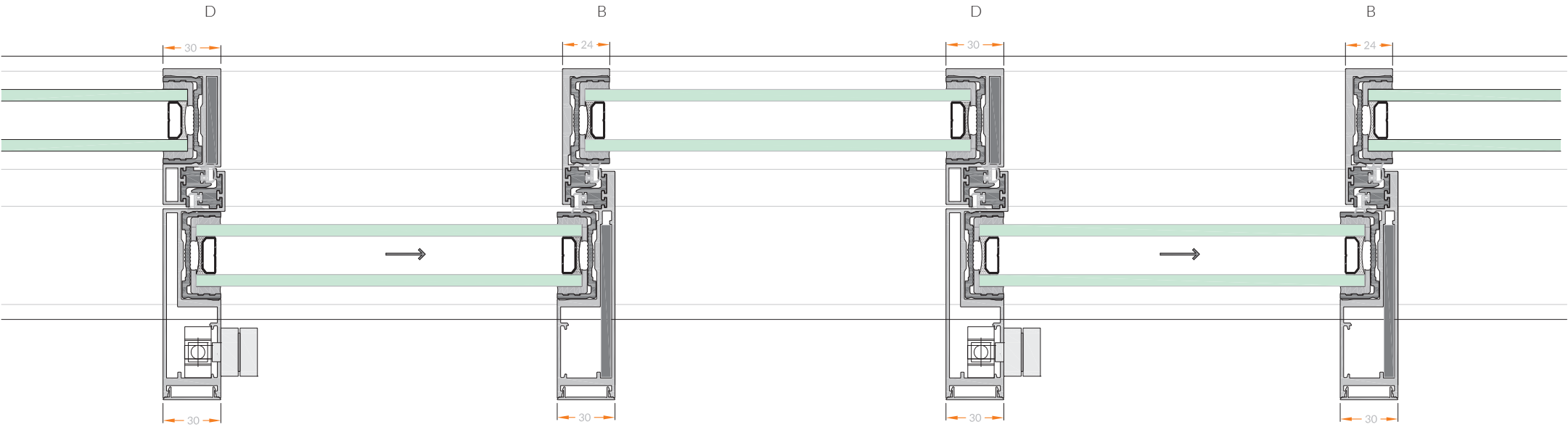

HORIZONTAL SECTION



SINGLE CORNER FRAME

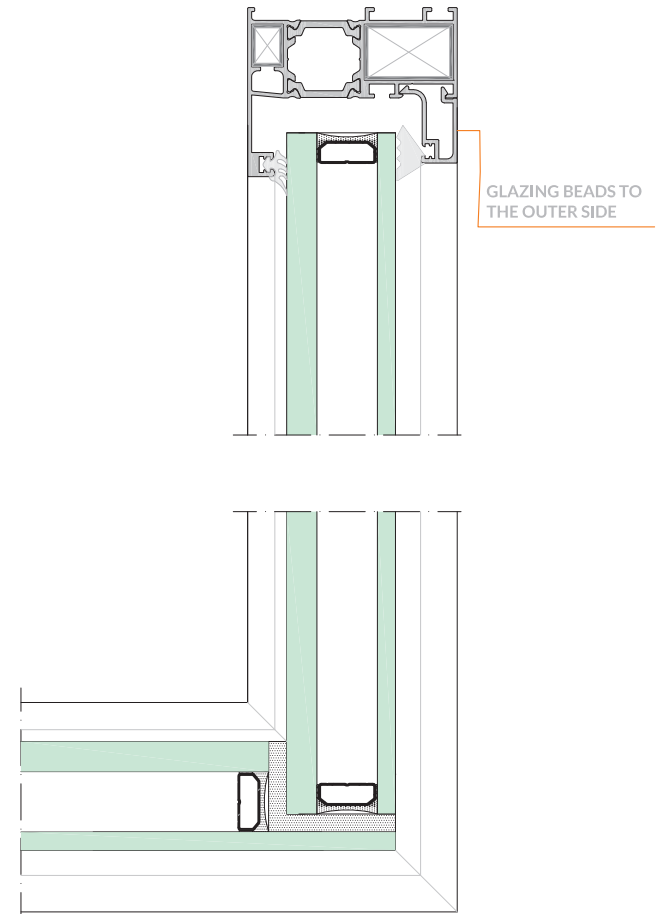
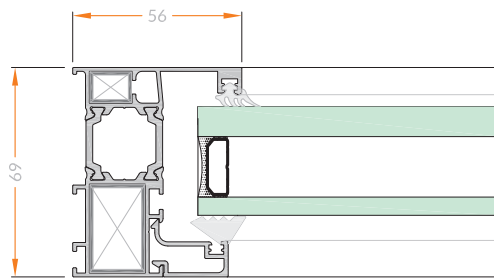
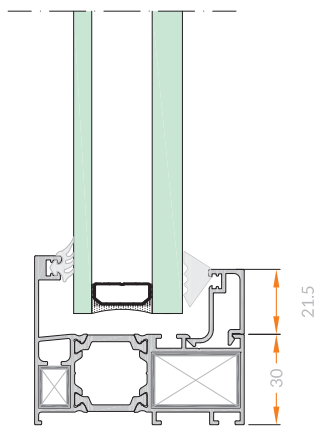
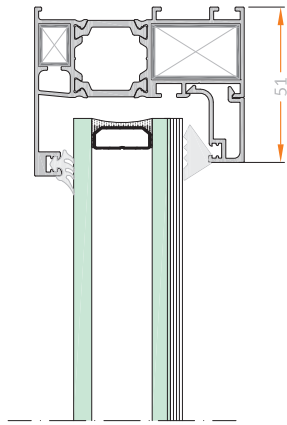

8.13

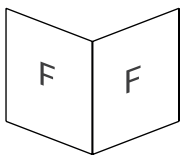

VERTICAL SECTION

HORIZONTAL SECTION

TWO TRACK CLOSED CORNER FRAMES

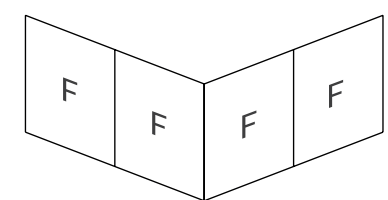
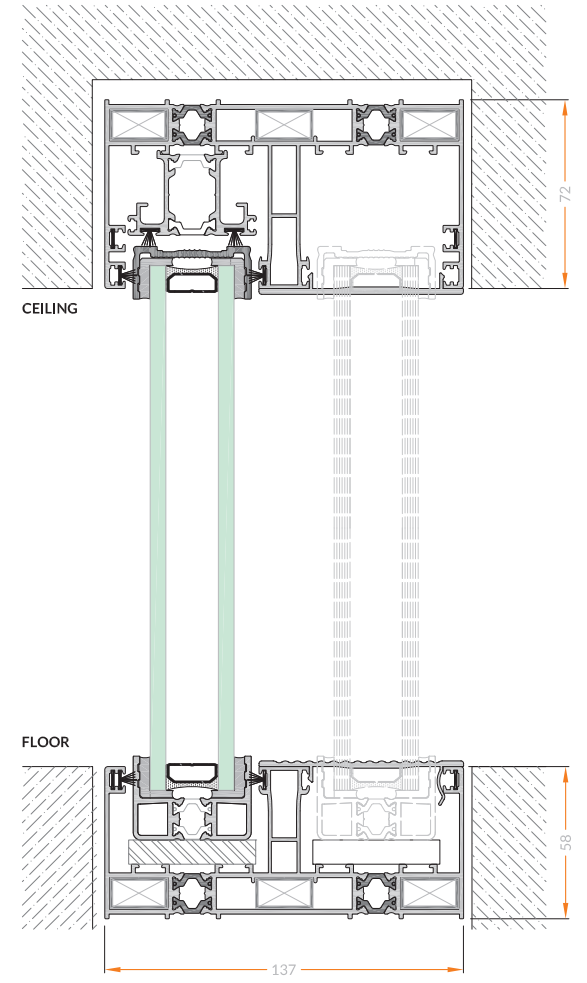
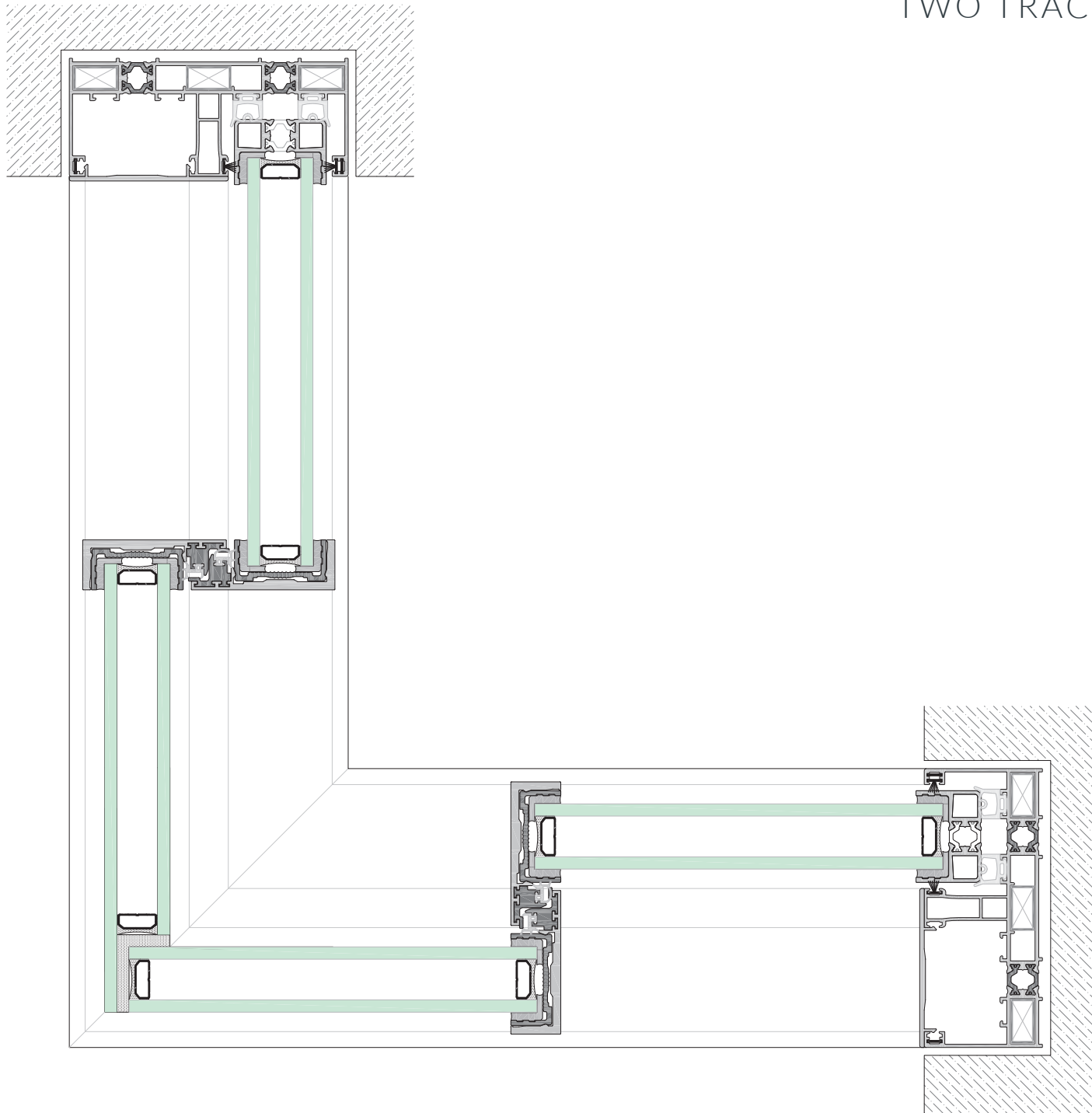

TWO TRACK OPEN CORNER FRAMES (SLIDING INSIDE)

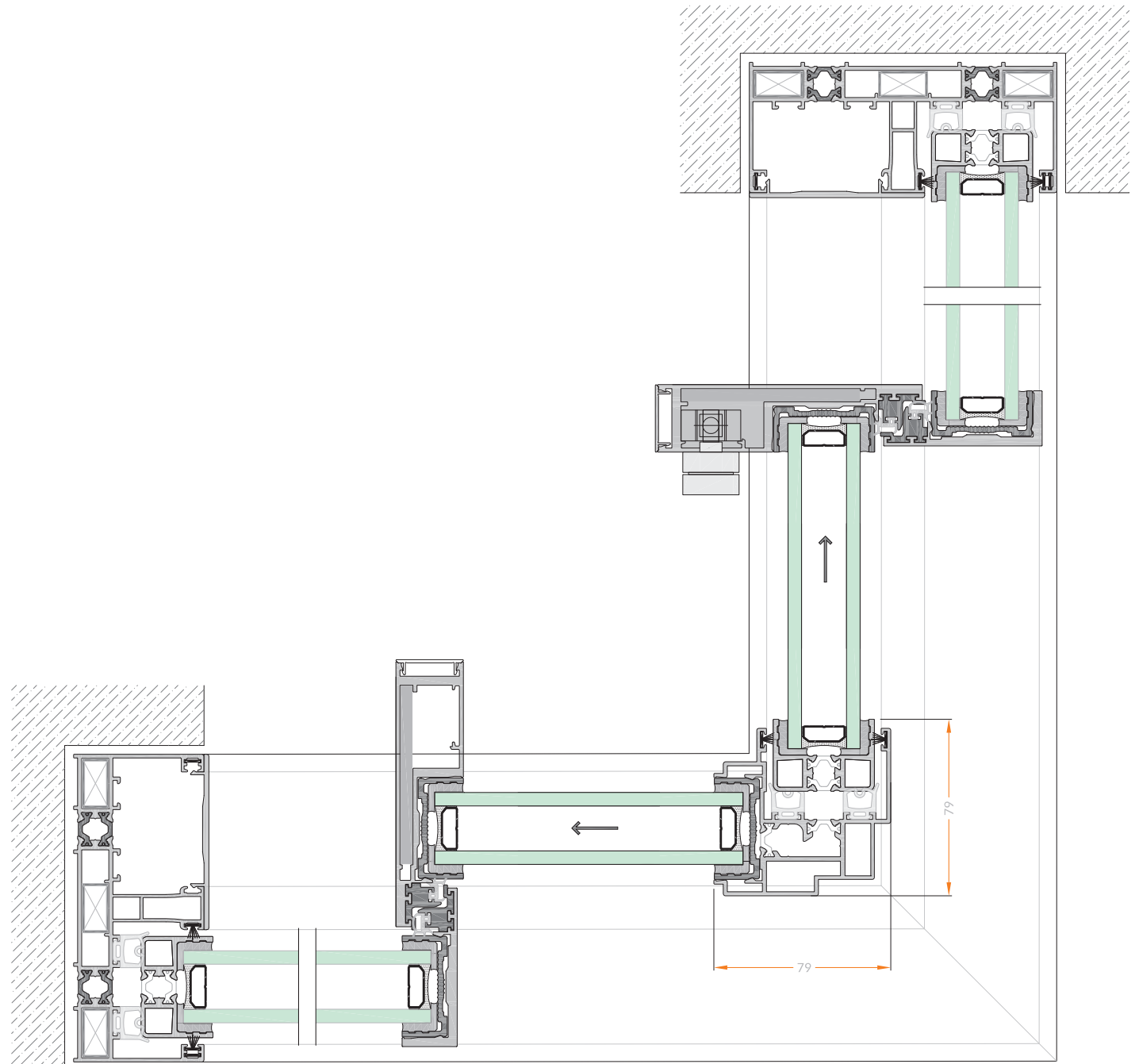
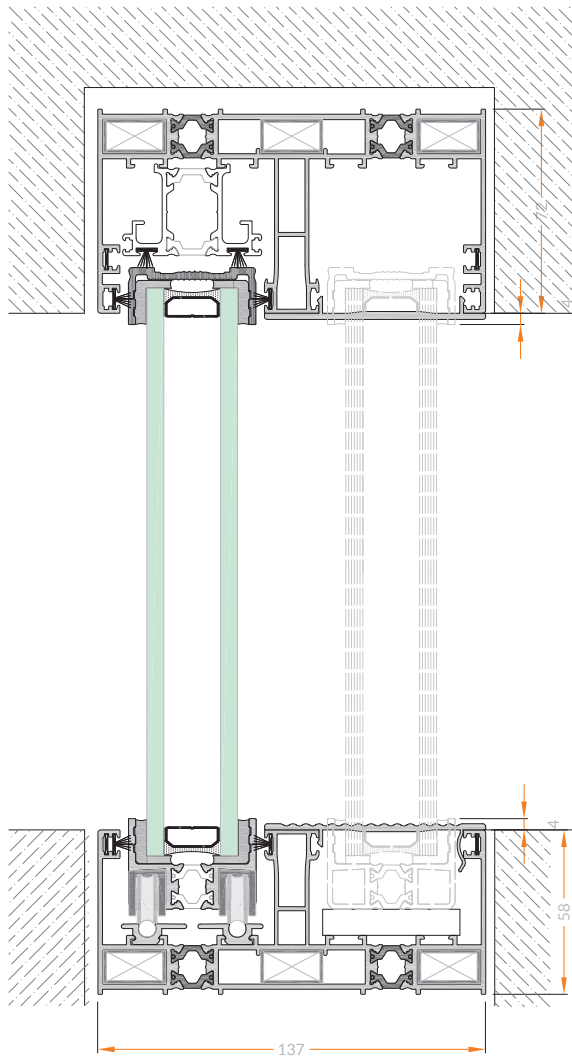

8.15

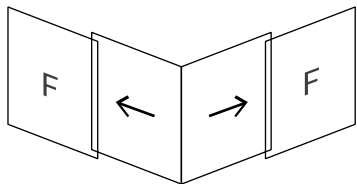

TWO TRACK OPEN CORNER FRAMES (SLIDING OUTSIDE)

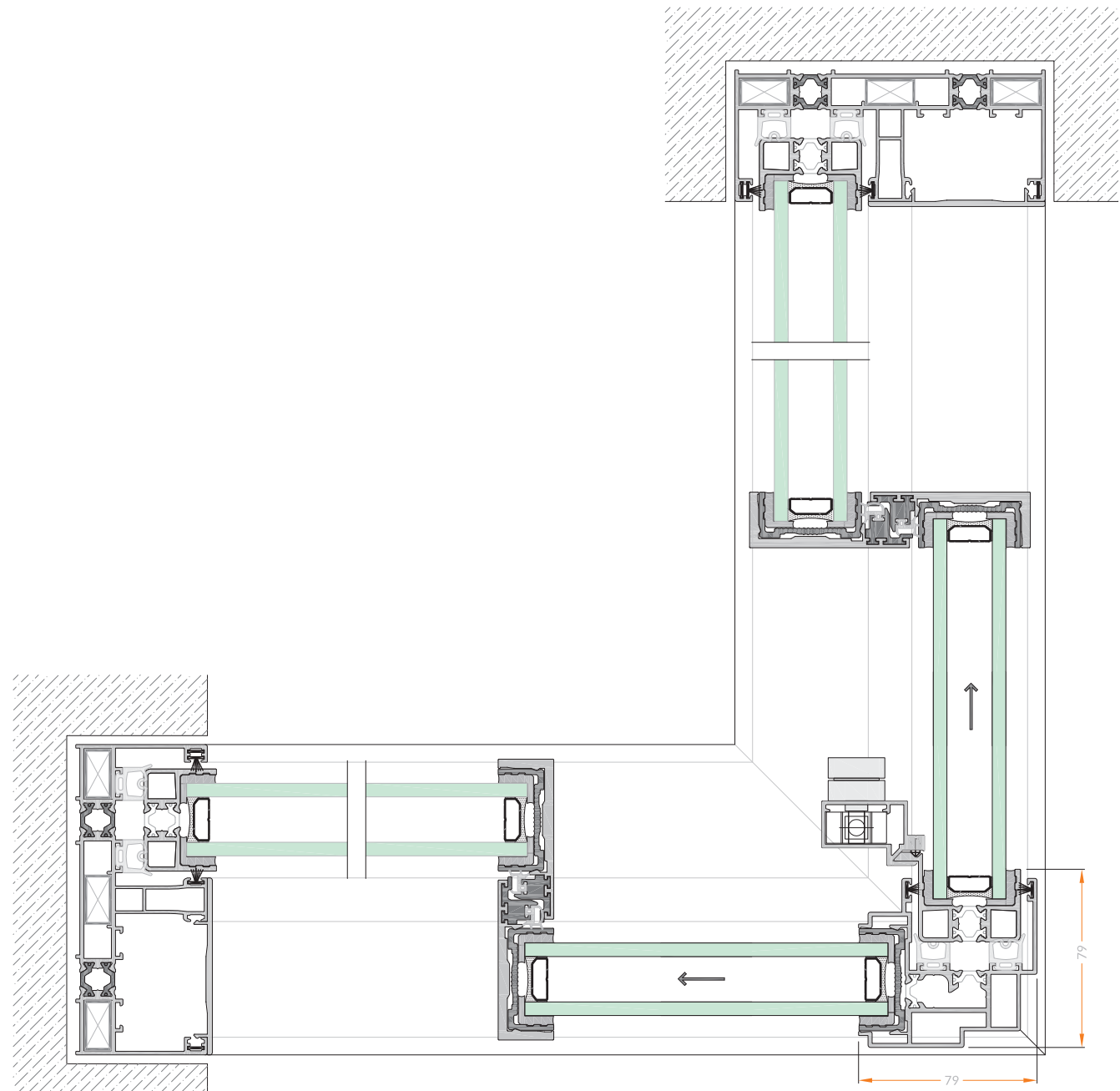
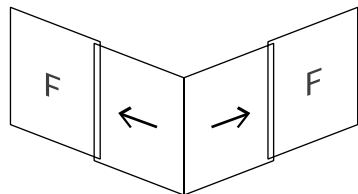
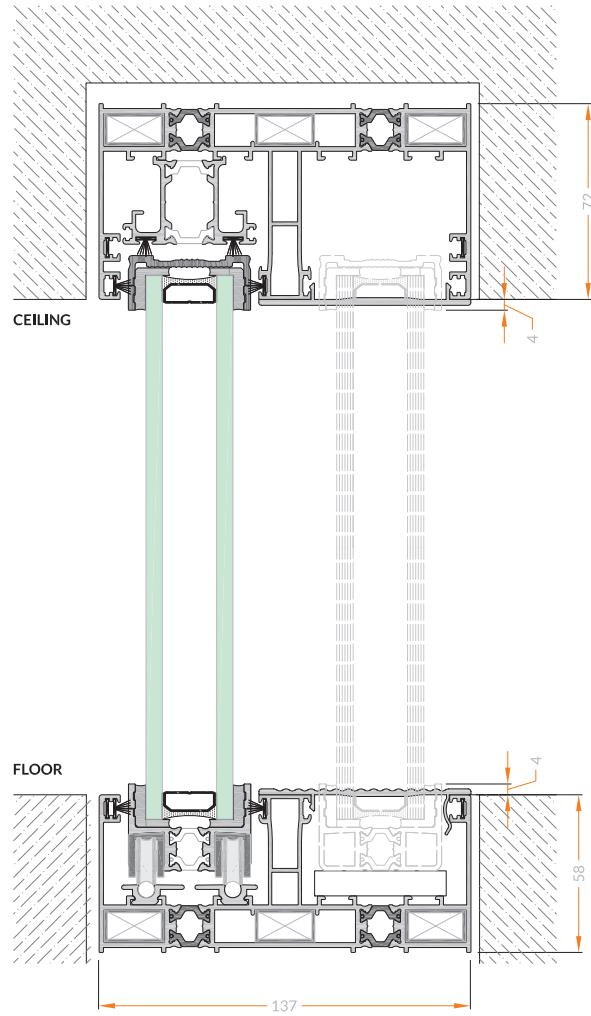

WIND LOAD DIAGRAMS

0,5
kN/m²

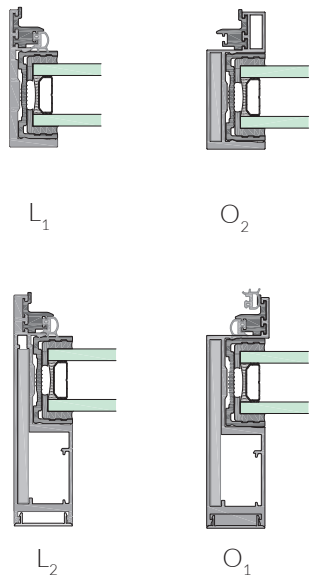
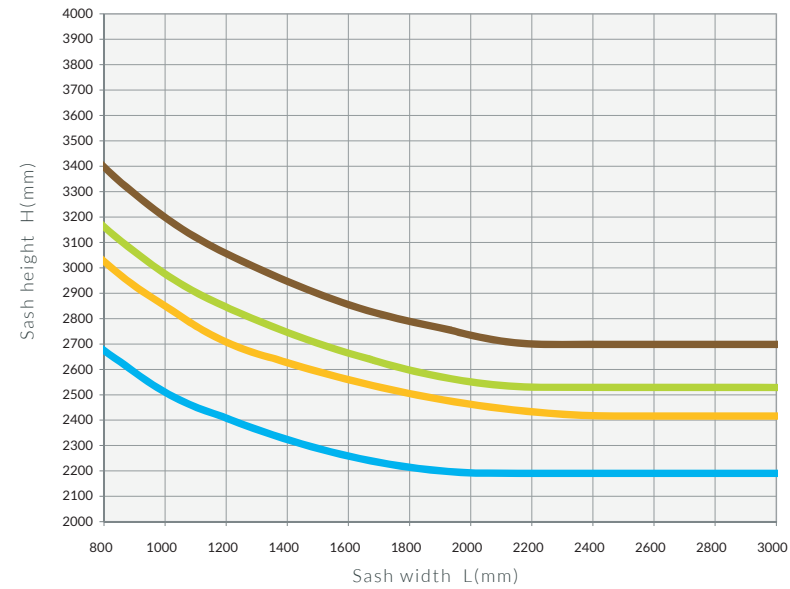
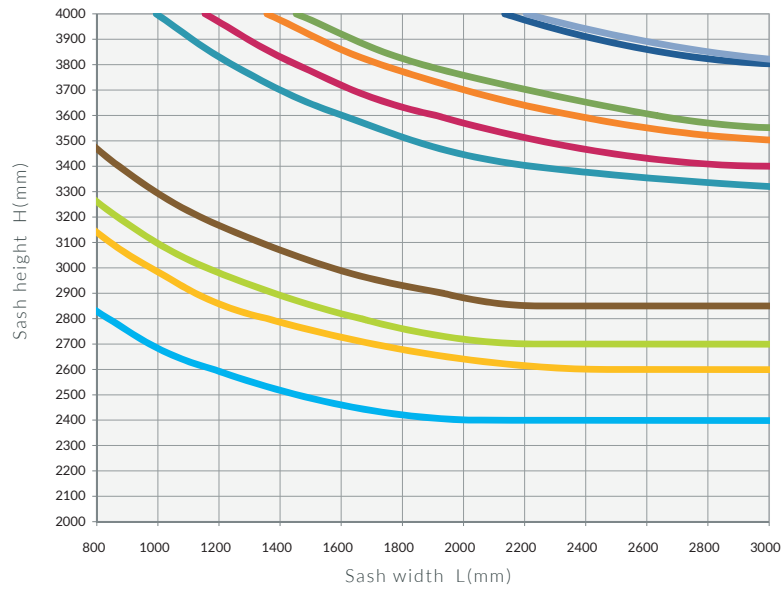

OMICRON

- O₁ + Steel reinf.
- L₂ + Steel reinf.
- L₂
- O₁
- L₂ + Alum. reinf.
- O₂
- O₂ + Steel reinf.
- O₂ + Alum. reinf.
- O₁ + Alum. reinf.
- L₁

- HA
- FA₁
- HB
- FA₂

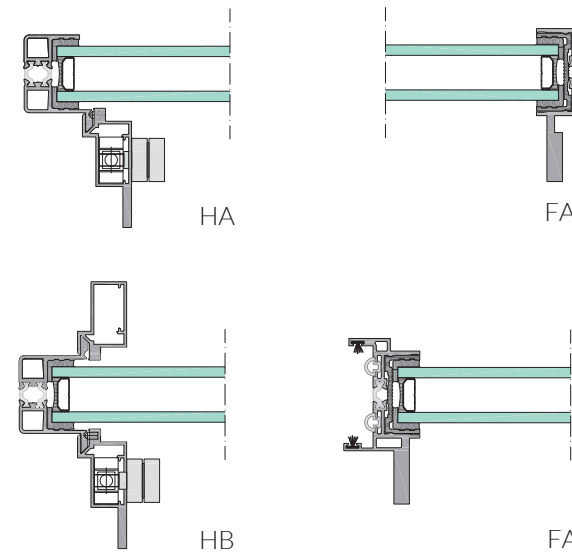





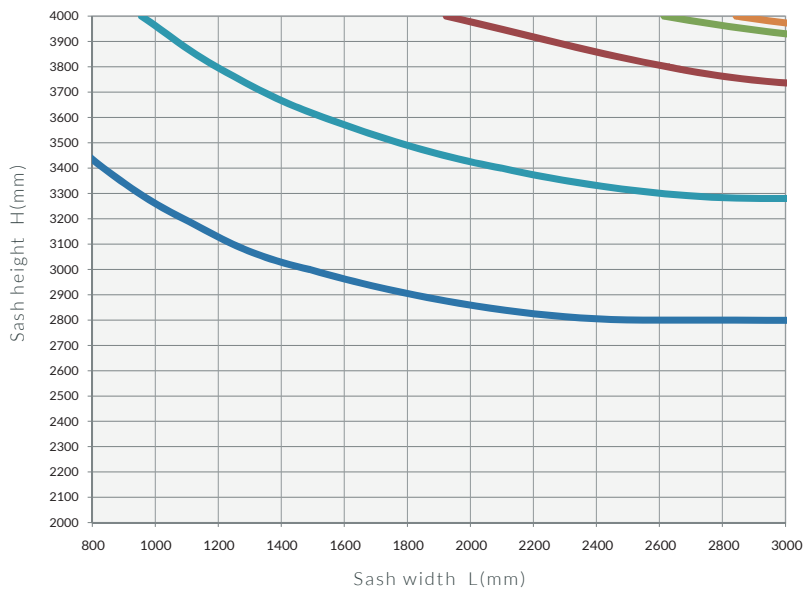

103
Km/h

WIND LOAD DIAGRAMS



ΩMEGA

-  D
-  C
-  B + Steel reinf.
-  B + Alum. reinf.
-  B
-  A

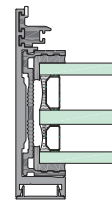

A

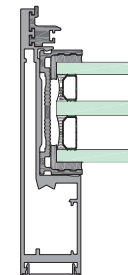

B

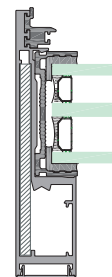

B + Alum. reinf.

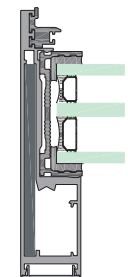

B + Steel reinf.

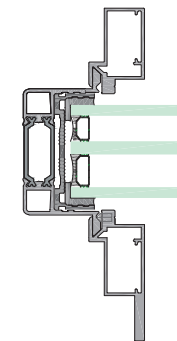
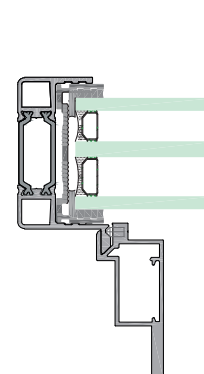

WIND LOAD DIAGRAMS

0,8
kN/m²

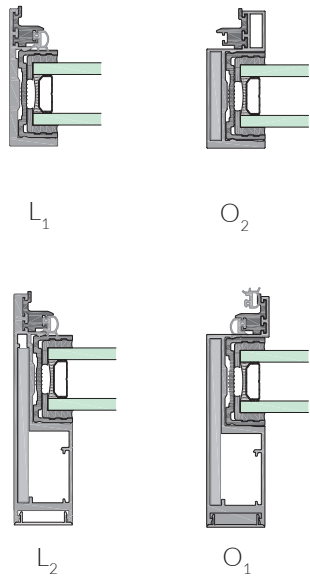
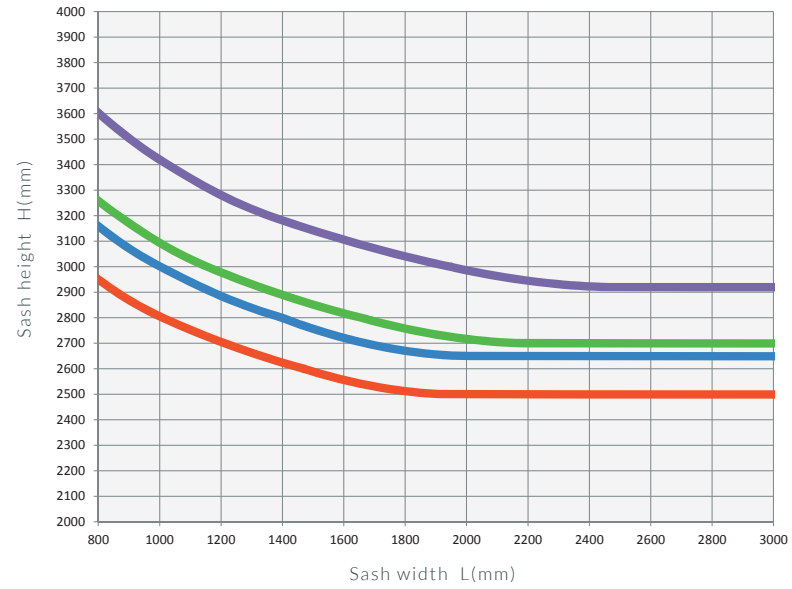
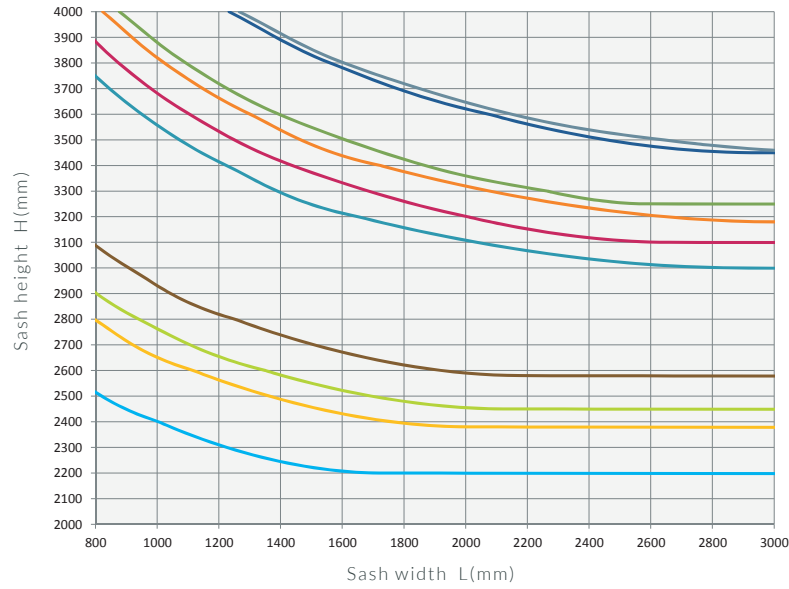

OMICRON

- O₁ + Steel reinf. —
- L₂ + Steel reinf. —
- L₂ —
- O₁ —
- L₂ + Alum. reinf. —
- O₂ —
- O₂ + Steel reinf. —
- O₂ + Alum. reinf. —
- O₁ + Alum. reinf. —
- L₁ —

HA

FA₁

HB



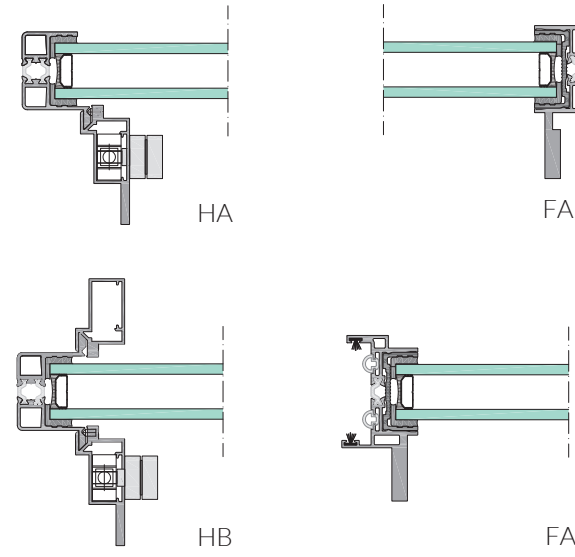

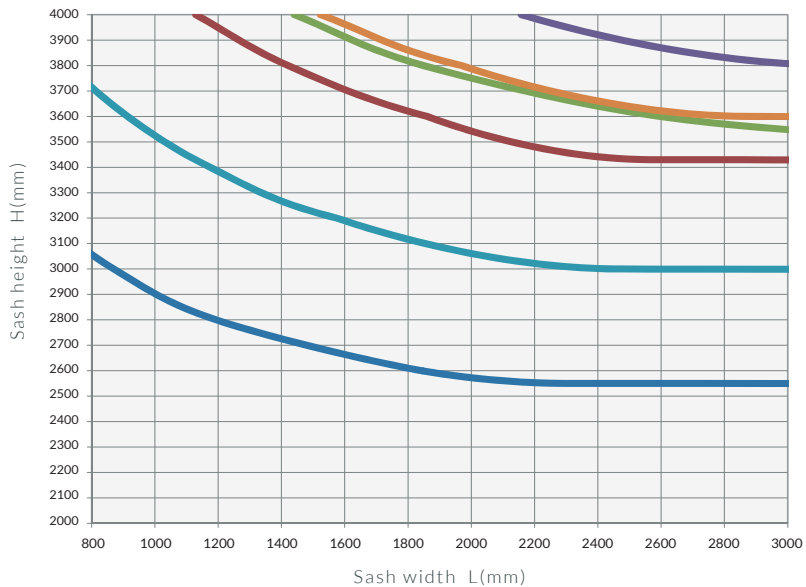

FA₂



130
Km/h



ΩMEGA

-  D
-  C
-  B + Steel reinf.
-  B + Alum. reinf.
-  B
-  A

WIND LOAD DIAGRAMS

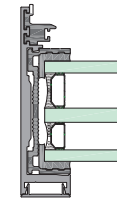

A

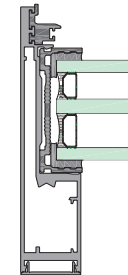

B

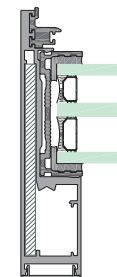

B + Alum. reinf.

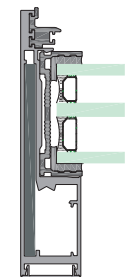

B + Steel reinf.

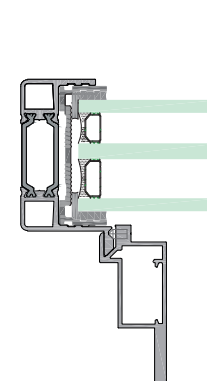

C

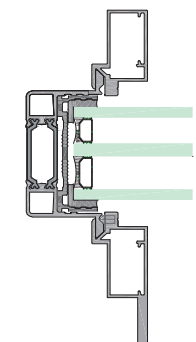

D

WIND LOAD DIAGRAMS

1,0
kN/m²

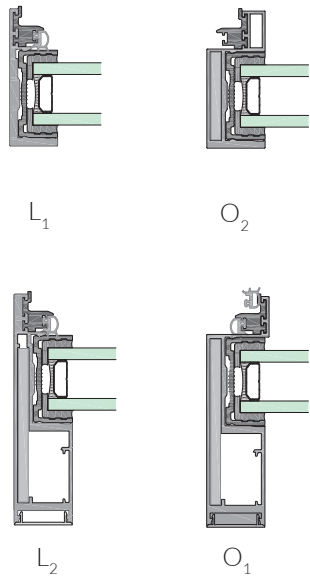
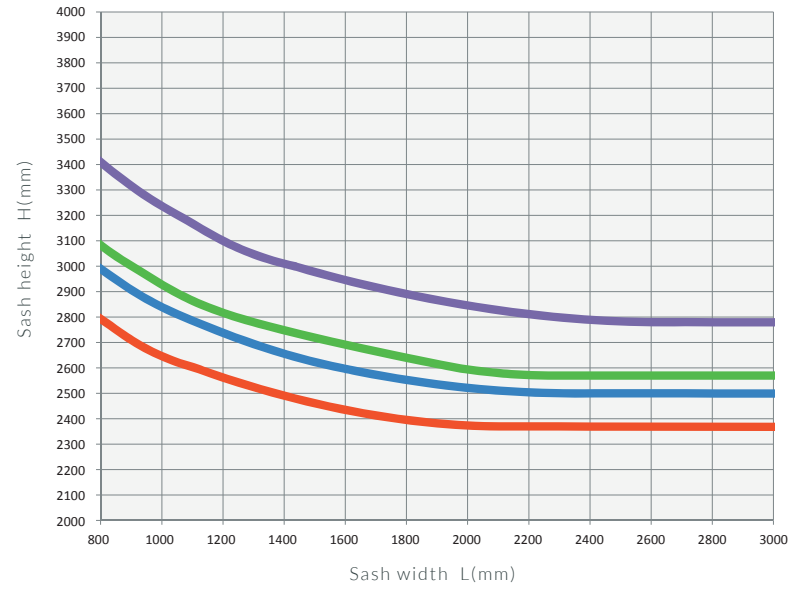
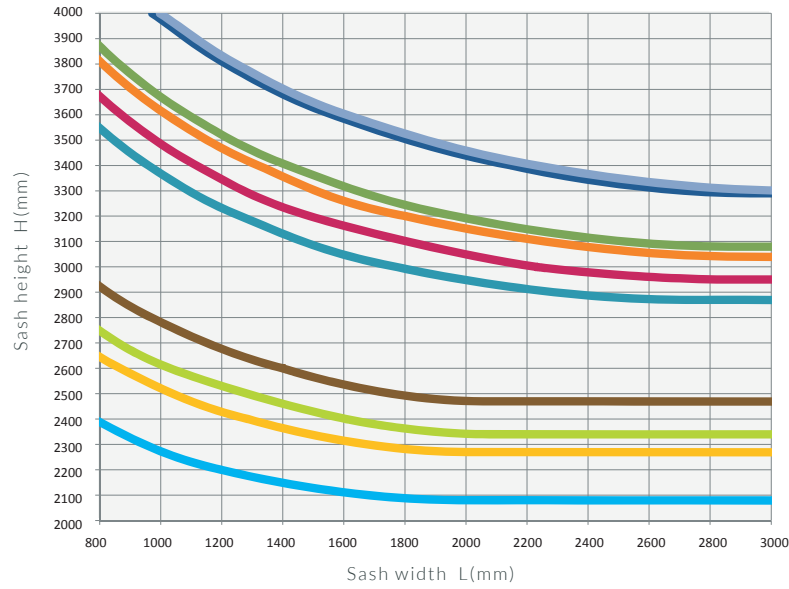

OMICRON

- O₁ + Steel reinf. —
- L₂ + Steel reinf. —
- L₂ —
- O₁ —
- L₂ + Alum. reinf. —
- O₂ —
- O₂ + Steel reinf. —
- O₂ + Alum. reinf. —
- O₁ + Alum. reinf. —
- L₁ —

- HA
- FA₁
- HB
- FA₂

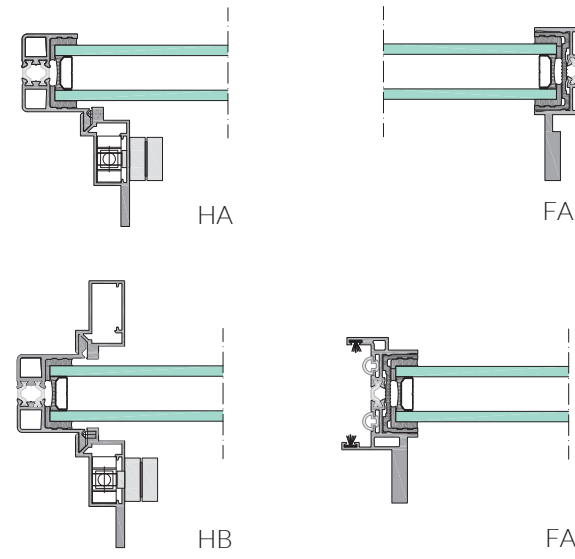

145
Km/h

WIND LOAD DIAGRAMS

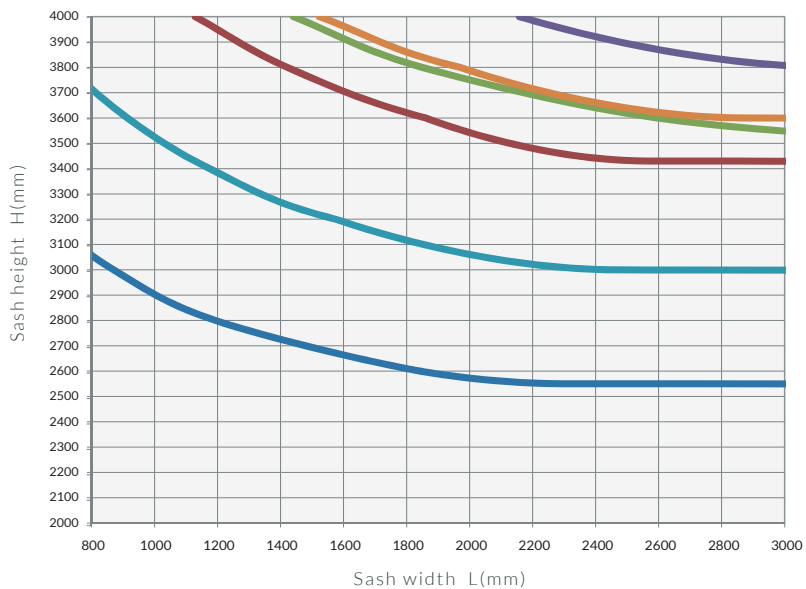

ΩMEGA

- D
- C
- B + Steel reinf.
- B + Alum. reinf.
- B
- A

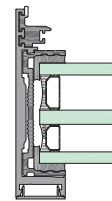

A

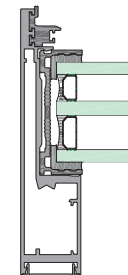

B

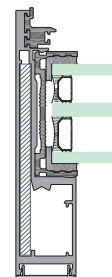

B + Alum. reinf.

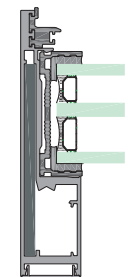

B + Steel reinf.

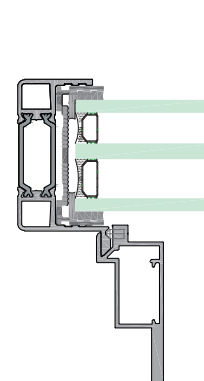

C

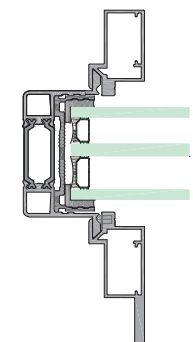

D

WIND LOAD DIAGRAMS

1,3
kN/m²

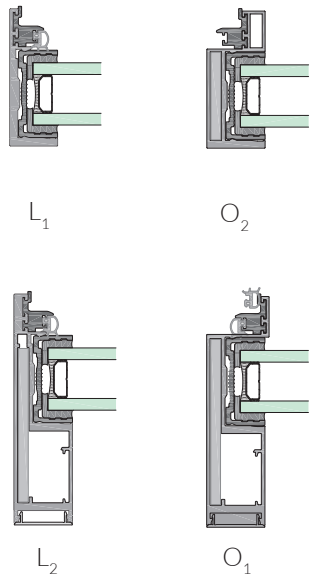
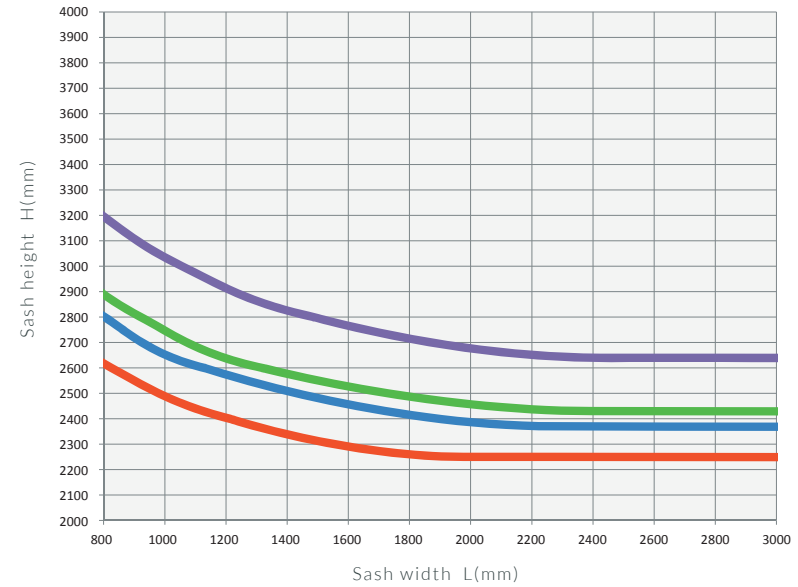
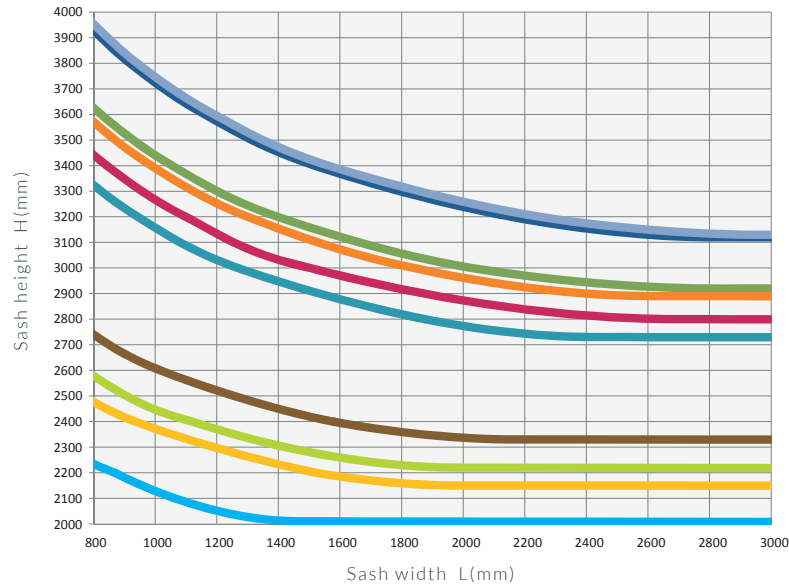

OMICRON

- O₁ + Steel reinf. —
- L₂ + Steel reinf. —
- L₂ —
- O₁ —
- L₂ + Alum. reinf. —
- O₂ —
- O₂ + Steel reinf. —
- O₂ + Alum. reinf. —
- O₁ + Alum. reinf. —
- L₁ —

HA

FA₁

HB

FA₂

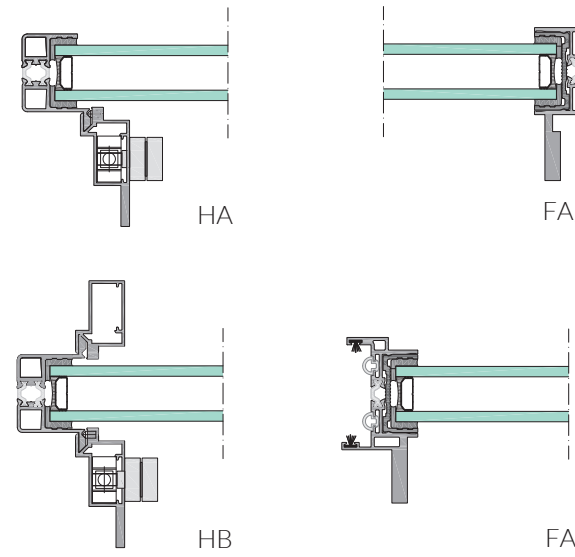

164
Km/h

WIND LOAD DIAGRAMS

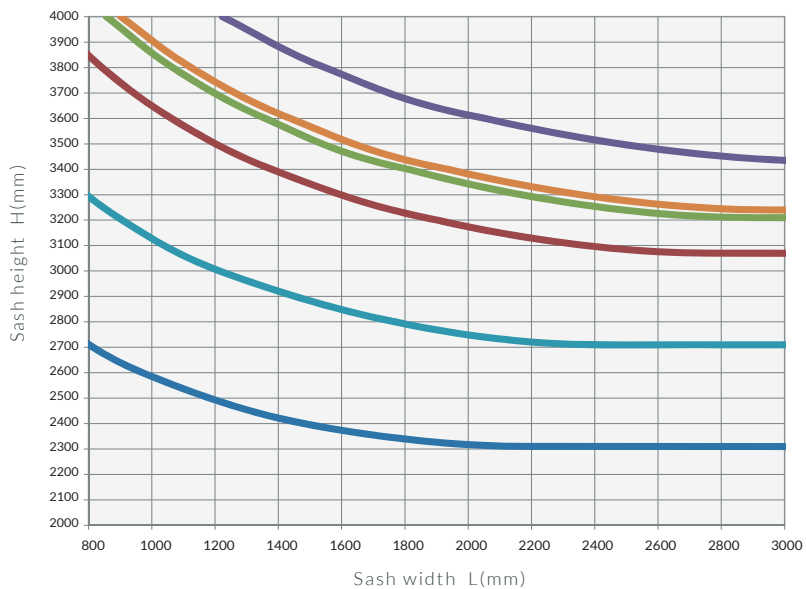

ΩMEGA

- D
- C
- B + Steel reinf.
- B + Alum. reinf.
- B
- A

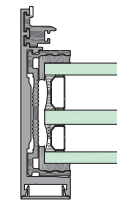

A

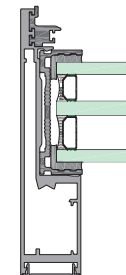

B

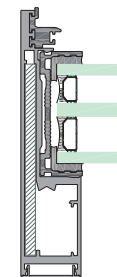

B + Alum. reinf.

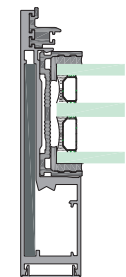

B + Steel reinf.

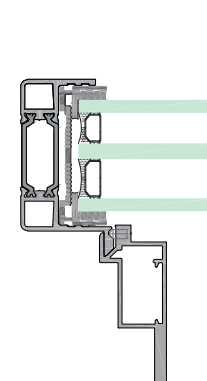

C

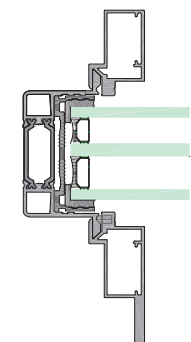

D

WIND LOAD DIAGRAMS

2,0
kN/m²

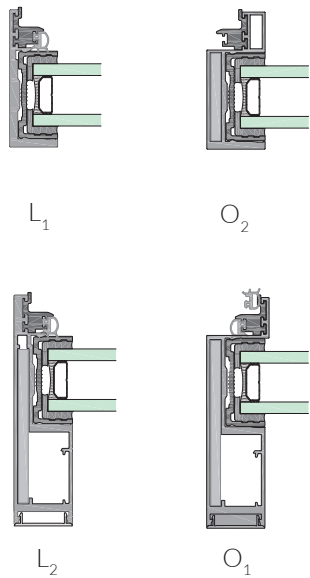
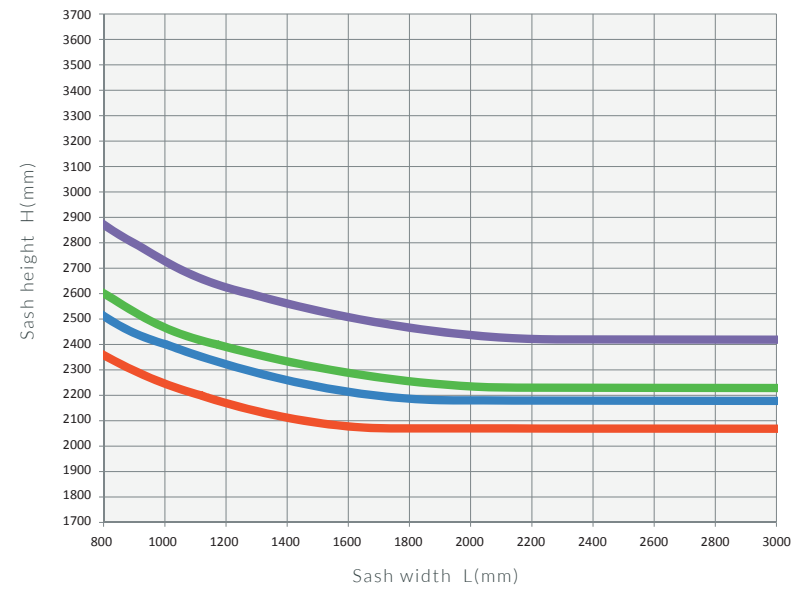
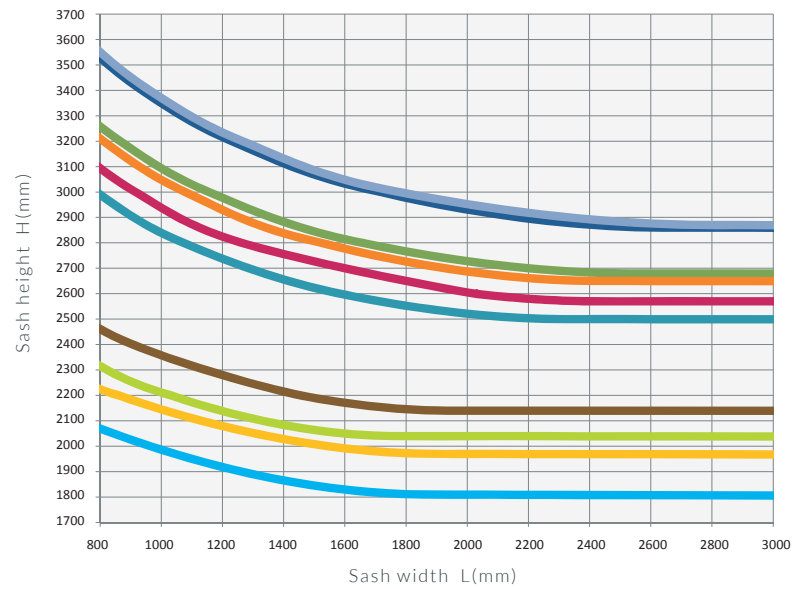

OMICRON

- O₁ + Steel reinf. —
- L₂ + Steel reinf. —
- L₂ —
- O₁ —
- L₂ + Alum. reinf. —
- O₂ —
- O₂ + Steel reinf. —
- O₂ + Alum. reinf. —
- O₁ + Alum. reinf. —
- L₁ —

HA

FA₁

HB

FA₂

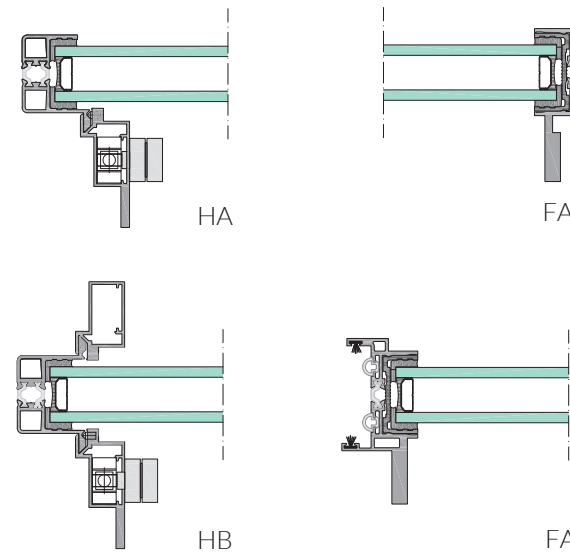

200
Km/h

WIND LOAD DIAGRAMS

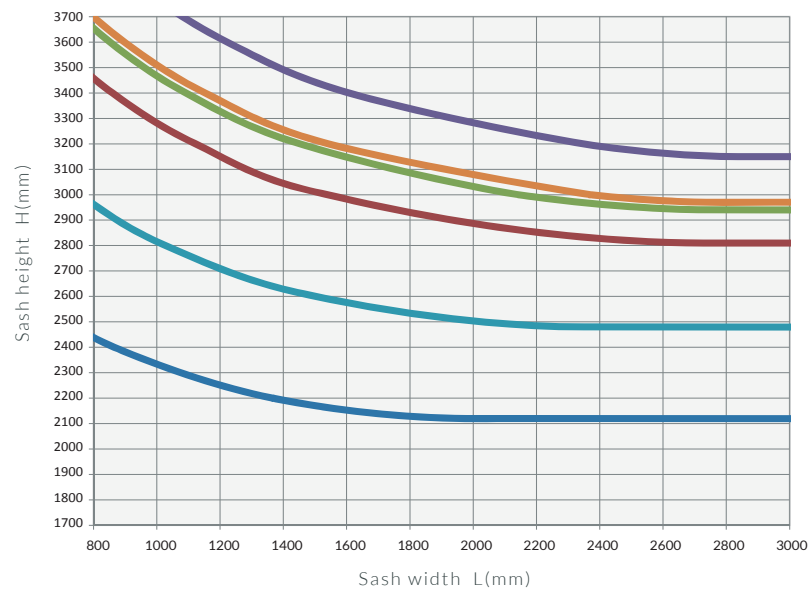

ΩMEGA

- D
- C
- B + Steel reinf.
- B + Alum. reinf.
- B
- A

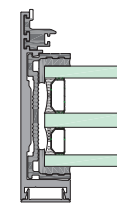

A

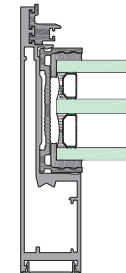

B

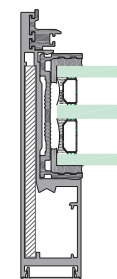

B + Alum. reinf.

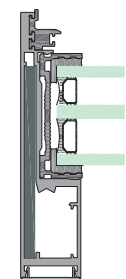

B + Steel reinf.

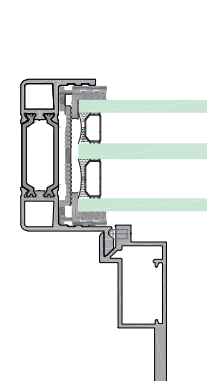

C

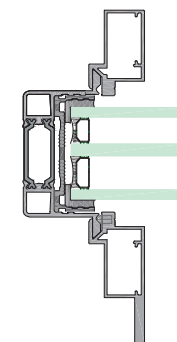

D

OMICRON • THERMAL PERFORMANCE

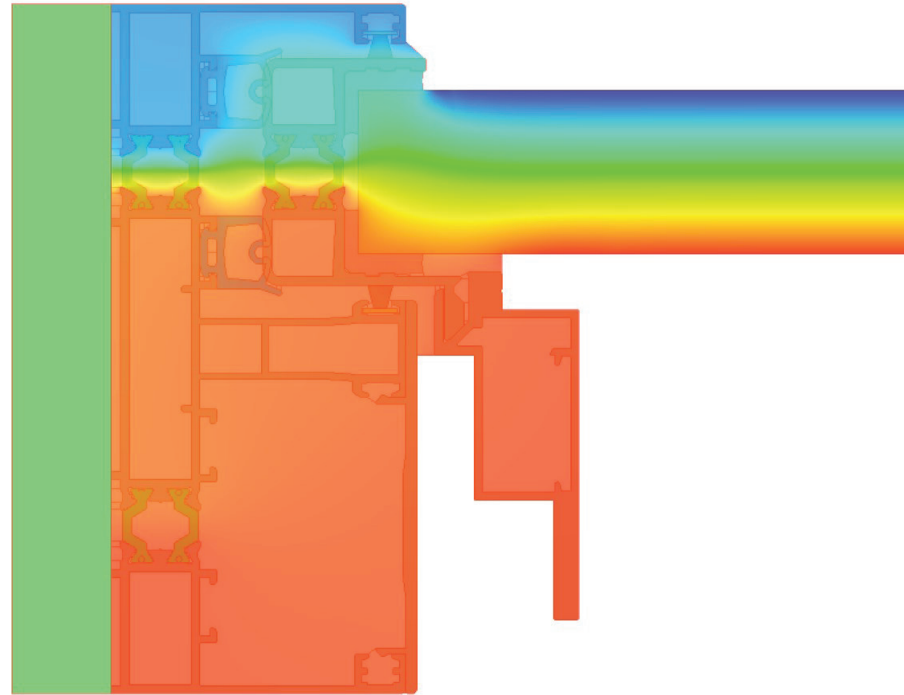

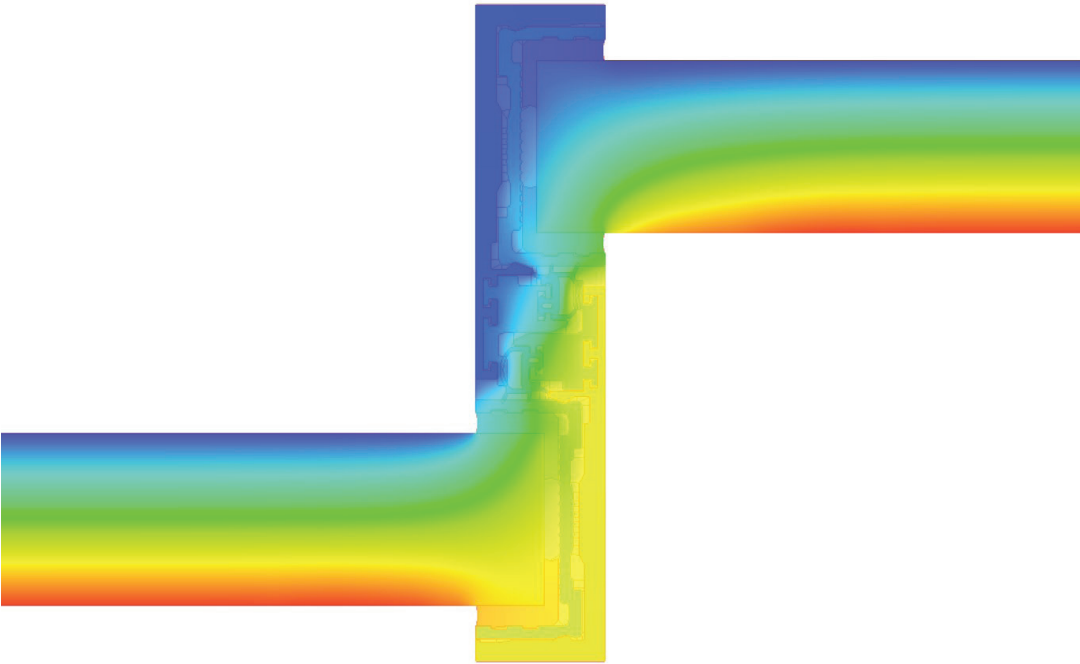

UW VALUES 0,7 - 1.7 W/M2K DEPENDING ON THE UG

ΩMEGA • THERMAL PERFORMANCE

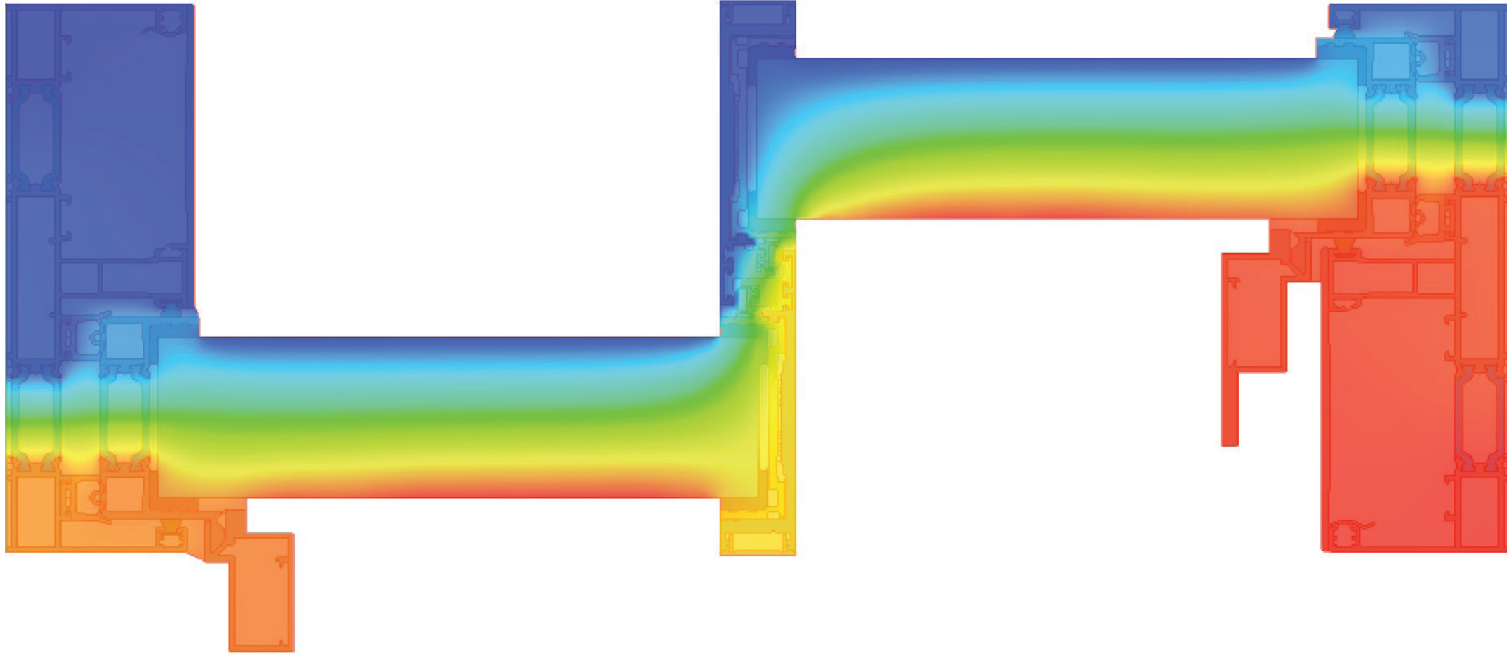

UW VALUES 0,7 - 1.7 W/M2K DEPENDING ON THE UG

ORAMA

MINI LOK

FRAMES

